

INTRODUCING

# FIBER-TECH™ TECHNOLOGY

by INTEX®

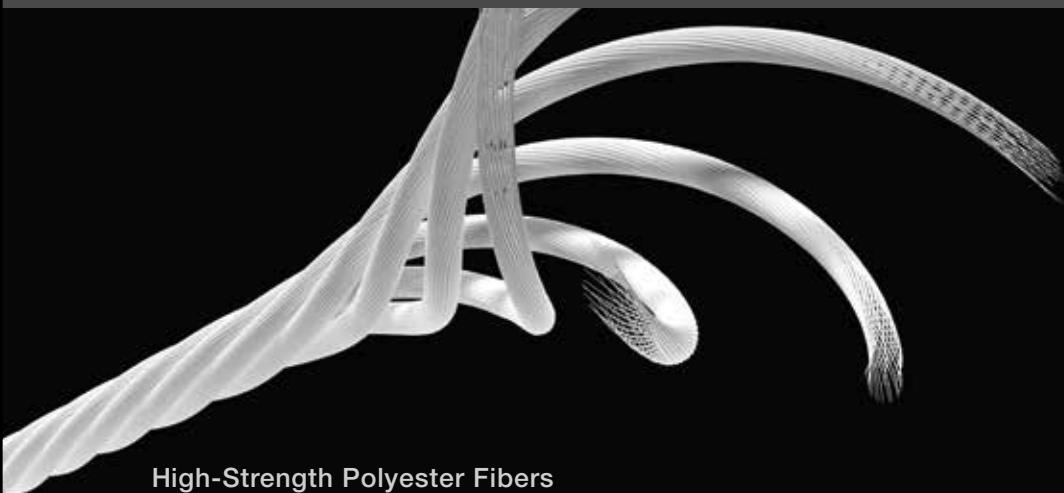

High-Strength Polyester Fibers



Fiber-Tech™ Interior Construction

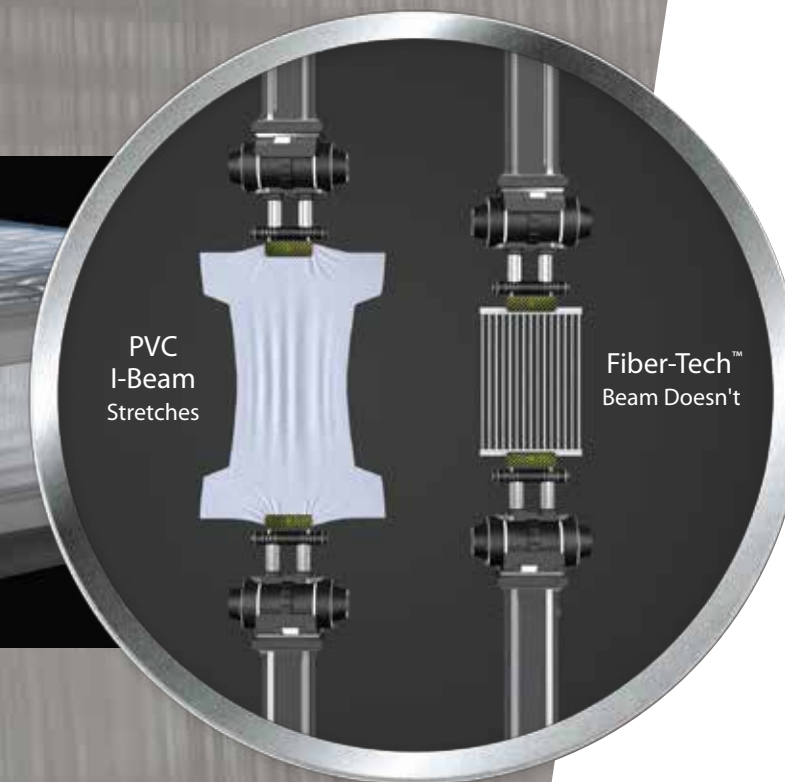

An Incredible Night's Sleep Starts With a Single Thread...

## CONTOURED SUPPORT SYSTEM

Our new innovative, patented Fiber-Tech™ Technology airbeds are comprised of thousands of high-strength polyester fibers. Unlike traditional airbed construction, these high-strength polyester fibers do not stretch over time, resulting in amazing durability for years of lasting comfort. Fiber-Tech™ interior construction provides the ideal firmness for superb support and rejuvenating sleep.



# Designed for Comfort Engineered for Durability

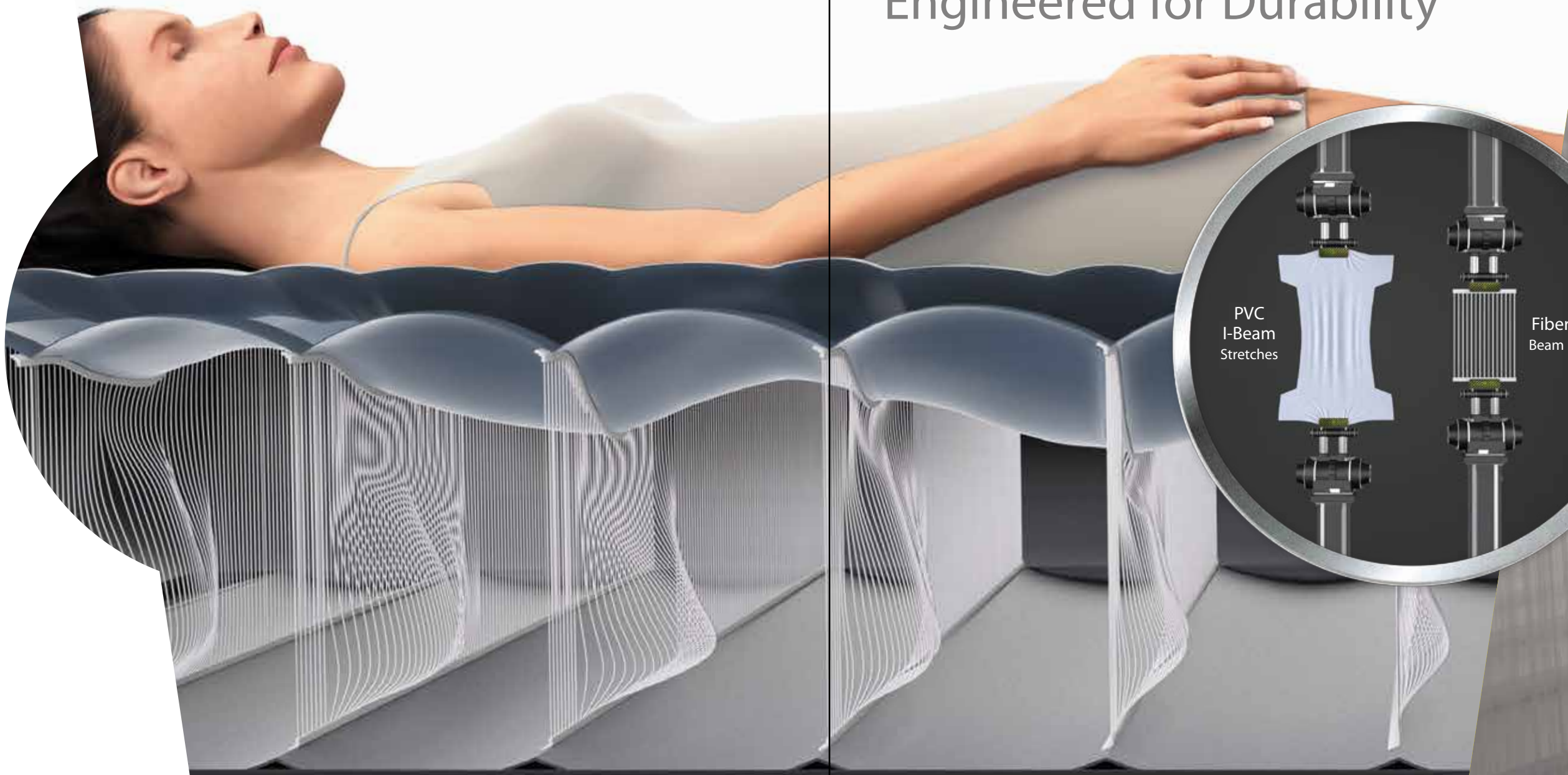

**FIBER-TECH™**  
TECHNOLOGY

Standard interior construction has been enhanced with lightweight, high-strength fibers for amazing durability and comfort!

U.S. Patent No. 8,562,773

# DURA-BEAM® SERIES DELUXE SINGLE-HIGH

WITH FIBER-TECH™ TECHNOLOGY

Introducing deluxe single high airbed with Fiber-Tech™ inner construction that can be used both indoors and outdoors. Recognizably many times more comfortable and durable than a traditional PVC air mattress, this entry level airbed is the perfect addition to any home.



## INDOOR / OUTDOOR MULTI-USE SINGLE-HIGH AIRBED

- Fiber-Tech™ Technology
- Quality tested flocked top and sides with vinyl bottom
- Strong and lightweight
- 2-in-1 valve

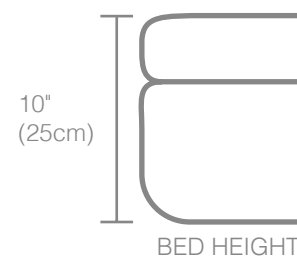
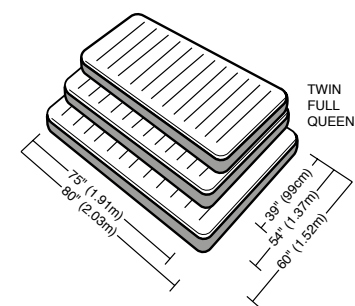
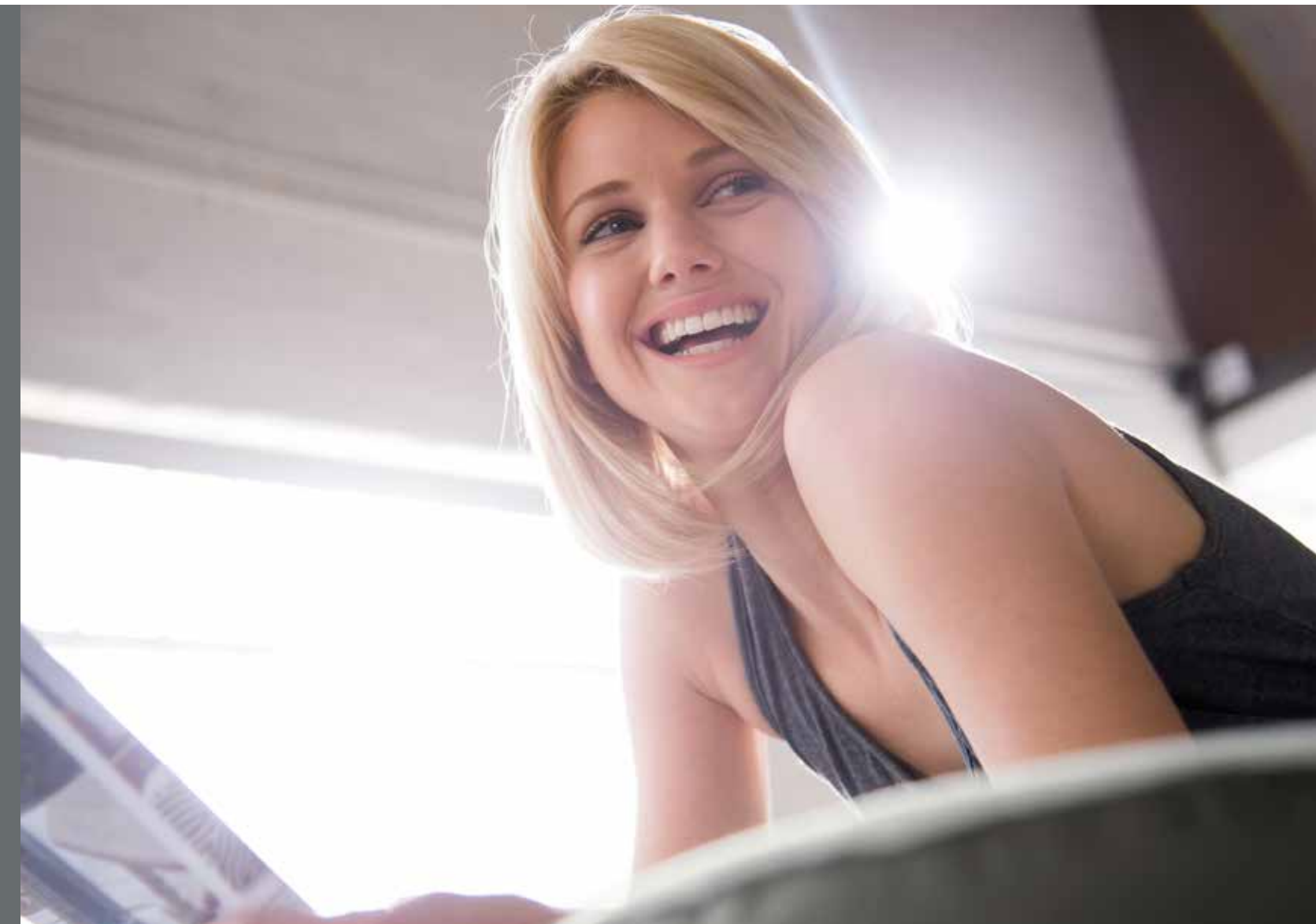

### AIRBED

only		Approximate Inflated Size	Case Pack	Case Weight
64701 / E	Twin	39" x 75" x 10" (99cm x 1.91m x 25cm)	4 ea	25.0 lb (11.4 kg)
64702 / E	Full	54" x 75" x 10" (1.37m x 1.91m x 25cm)	3 ea	24.9 lb (11.3 kg)
64703 / E	Queen	60" x 80" x 10" (1.52m x 2.03m x 25cm)	3 ea	28.6 lb (13.0 kg)

Introducing 10" (25cm) Deluxe Single-High Airbed with Fiber-Tech™ Technology. The perfect all-around sleeping solution, this compact airbed provides both campers and in-home users with the convenience of a low-profile, light-weight, comfortable bed that is built for long-lasting durability.

This airbed is covered in a soft, flocked sleeping surface for enhanced comfort. Our patented Fiber-Tech™ interior construction provides superb support and structural stability for a restful night's sleep. Made for durability and comfort, anywhere you go.

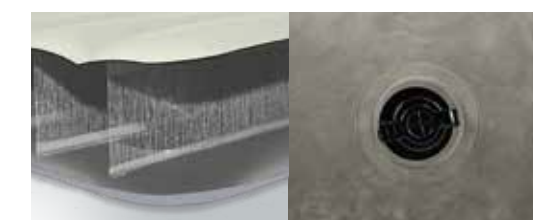

Fiber-Tech™ Technology

2-in-1 valve with extra-wide openings for fast inflating and deflating

new!

# DURA-BEAM® SERIES PILLOW REST RAISED BED

WITH FIBER-TECH™ TECHNOLOGY



### ELEVATED FOR CONVENIENCE

- Fiber-Tech™ Technology
- Quality tested flocked top
- New horizontal beam construction
- Raised height 16½" (42cm)
- Built-in pillow



AC Electric Pump INFLATING TIMES*	
TWIN	2 Minutes
QUEEN	3½ Minutes

\*INFLATING TIME VARIES BY MATTRESS SIZE AND DESIRED FIRMNESS

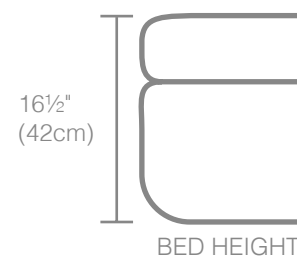
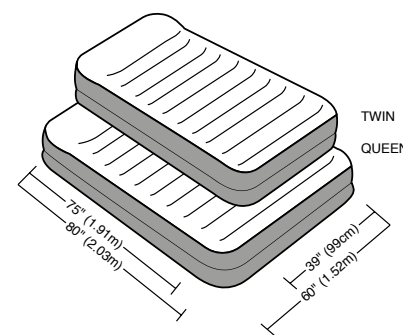

### AIRBED

with Built-in Electric Pump

		Approximate Inflated Size	Built-in Pump	Case Pack	Case Weight
64421E	Twin	39" x 75" x 16½"	110 - 120V	3 ea	31.6 lb (14.4 kg)
64422		(99cm x 1.91m x 42cm)	220 - 240V		
64423E	Queen	60" x 80" x 16½"	110 - 120V	2 ea	31.2 lb (14.2 kg)
64424		(1.52m x 2.03m x 42cm)	220 - 240V		

The new and improved Dura-Beam® Series version of the classic pillow rest raised bed offers ideal comfort and durability. The Fiber-Tech™ Technology beams do not stretch over time, offering long lasting structural stability. The 16½" (42cm) raised height provides easy accessibility and a closer feel to traditional mattresses, making it the perfect choice for house guests, dorm rooms and even camping trips.



Fiber-Tech™ Technology

Built-in AC Electric Pump

Built-in pillow for added convenience

# DURA-BEAM® SERIES COMFORT-PLUSH

WITH FIBER-TECH™ TECHNOLOGY

Our most popular bed in the Dura-Beam® series with three different bed heights to choose from, our Comfort-Plush beds offer the perfect combination of luxurious comfort and convenience.



Each bed is covered in plush flocking that is soft to the touch, and the horizontal air chambers provide added stability and support around the entire bed. For extra convenience, this bed comes with a powerful built-in electric pump for fast inflation and deflation.

13" (33cm) BED HEIGHT

AC Electric Pump INFLATING TIMES*	
TWIN	2 Minutes
FULL	3 Minutes
QUEEN	3 Minutes

\* INFLATING TIME VARIES BY MATTRESS SIZE AND DESIRED FIRMNESS

## COMFORT-PLUSH HORIZONTAL BEAM AIRBED

- Fiber-Tech™ Technology
- Quality tested flocked top and sides with vinyl bottom



18" (46cm) BED HEIGHT

AC Electric Pump INFLATING TIMES*	
TWIN	2½ Minutes
QUEEN	4 Minutes

\* INFLATING TIME VARIES BY MATTRESS SIZE AND DESIRED FIRMNESS

22" (56cm) BED HEIGHT

AC Electric Pump INFLATING TIMES*	
QUEEN	4½ Minutes

\* INFLATING TIME VARIES BY MATTRESS SIZE AND DESIRED FIRMNESS

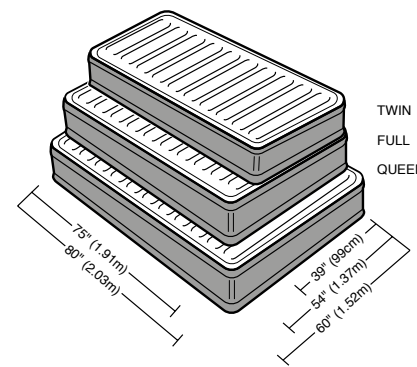
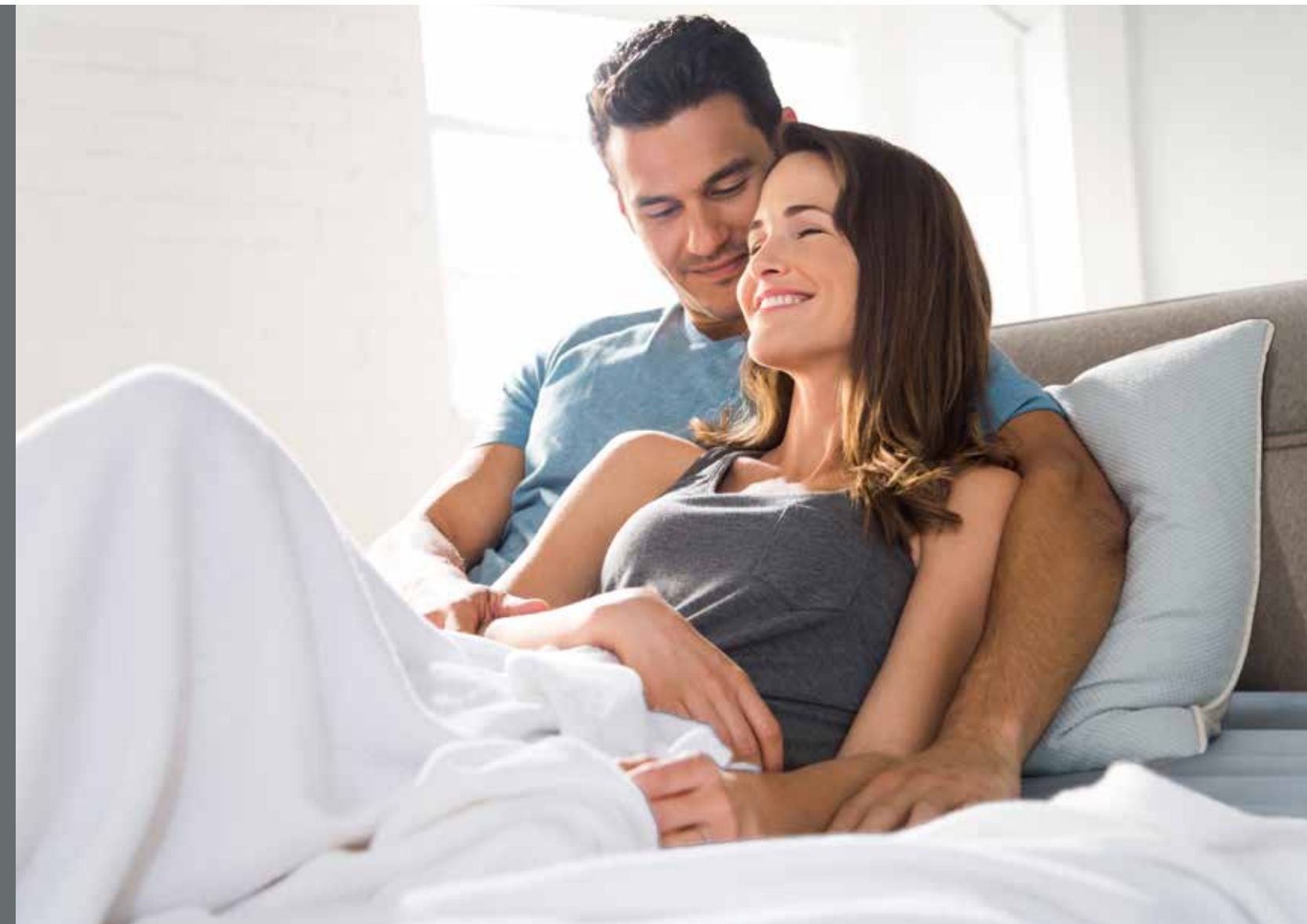

AIRBED with Built-in Electric Pump		Approximate Inflated Size	Built-in Pump	Case Pack	Case Weight
67765E	Twin	39" x 75" x 13" (99cm x 1.91m x 33cm)	110 - 120V	3 ea	39.8 lb (18.1 kg)
67766			220 - 240V		
67767E	Full	54" x 75" x 13" (1.37m x 1.91m x 33cm)	110 - 120V	2 ea	32.4 lb (14.7 kg)
67768			220 - 240V		
67769E	Queen	60" x 80" x 13" (1.52m x 2.03m x 33cm)	110 - 120V	2 ea	36.7 lb (16.7 kg)
67770			220 - 240V		

AIRBED with Built-in Electric Pump		Approximate Inflated Size	Built-in Pump	Case Pack	Case Weight
64411E	Twin	39" x 75" x 18" (99cm x 1.91m x 46cm)	110 - 120V	3 ea	44.0 lb (20.0 kg)
64412			220 - 240V		
64413E	Queen	60" x 80" x 18" (1.52m x 2.03m x 46cm)	110 - 120V	2 ea	40.9 lb (18.6 kg)
64414			220 - 240V		
64417E	Queen	60" x 80" x 22" (1.52m x 2.03m x 56cm)	110 - 120V	2 ea	46.7 lb (21.2 kg)
64418			220 - 240V		

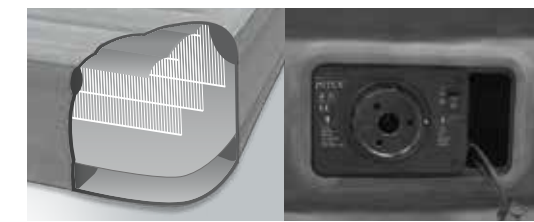

Fiber-Tech™ Technology

Built-in AC electric pump

new!

# DURA-BEAM® SERIES DELUXE PILLOW REST RAISED BED

WITH FIBER-TECH™ TECHNOLOGY



## BUILT-IN PILLOW AND SOFT FLOCKED TOP FOR COMFORT

- Fiber-Tech™ Technology
- Quality tested flocked top
- New horizontal beam construction
- Raised height 16½" (42cm)
- Built-In Pillow



AC Electric Pump INFLATING TIMES*	
TWIN	2 Minutes
QUEEN	3½ Minutes

\*INFLATING TIME VARIES BY MATTRESS SIZE AND DESIRED FIRMNESS

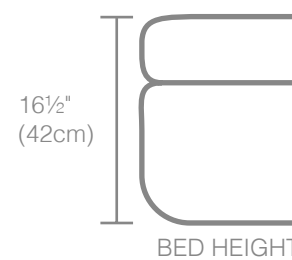
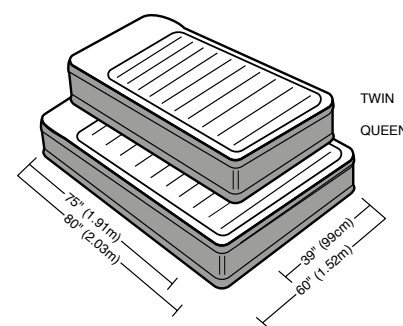

## AIRBED

with Built-in Electric Pump

		Approximate Inflated Size	Built-in Pump	Case Pack	Case Weight
64431E	Twin	39" x 75" x 16½"	110 - 120V	3 ea	36.6 lb (16.6 kg)
64432		(99cm x 1.91m x 42cm)	220 - 240V		
64435E	Queen	60" x 80" x 16½"	110 - 120V	2 ea	34.8 lb (15.8 kg)
64436		(1.52m x 2.03m x 42cm)	220 - 240V		

The deluxe version of our Pillow Rest Raised Bed has reached another level of luxury. Made with the innovative Fiber-Tech™ construction, this mattress is firmer and more durable than ever before. The plush and soft surface with raised pillow make this bed a premium sleeping experience with extra head support.



Deluxe Pillow Rest Construction

Built-in AC Electric Pump

Built-in pillow for added convenience

new!

DURA-BEAM® SERIES  
RAISED DOWNY BED  
WITH FIBER-TECH™ TECHNOLOGY



ELEVATED FOR COMFORT  
& CONVENIENCE

- Fiber-Tech™ Technology
- New horizontal beam construction
- 22" (56cm) Raised height
- Flocked mattress surface



<b>AC</b> Electric Pump INFLATING TIMES*	
QUEEN	4½ Minutes

\*INFLATING TIME VARIES BY MATTRESS SIZE AND DESIRED FIRMNESS

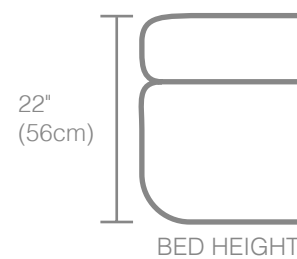
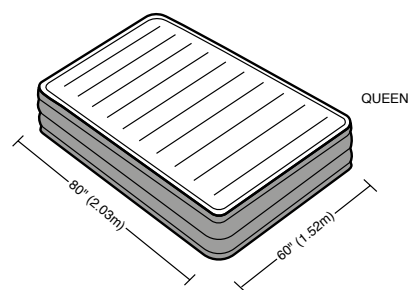

**AIRBED**

with Built-in Electric Pump

		Approximate Inflated Size	Built-in Pump	Case Pack	Case Weight
64439E	Queen	60" x 80" x 22"	110 - 120V	2 ea	37.2 lb (16.9 kg)
64440		(1.52m x 2.03m x 56cm)	220 - 240V		

Our classic Raised Downy Bed has been modified for an even better sleeping experience. PVC inner construction has been replaced with the revolutionary Fiber-Tech™ Technology. Fiber-Tech™ threads result in a lighter, firmer, and more durable mattress. Overnight guests will enjoy the added comfort, support and firmness that Fiber-Tech™ brings to this bed. The 22" (56cm) height provides a tall sleeping surface, enabling easy access on and off the mattress.



Fiber-Tech™ Technology

Built-in AC Electric Pump

new!

# DURA-BEAM® SERIES ULTRA PLUSH BED

WITH FIBER-TECH™ TECHNOLOGY



## ELEVATED WITH BUILT-IN ELECTRIC PUMP

- Fiber-Tech™ Technology
- Textured pillowtop for added comfort
- 18" (46cm) Raised height
- Built-in pump for rapid inflation and deflation



CARRY BAG    SHELF BOX    FOLDS COMPACTLY    BUILT-IN AIR PUMP

AC Electric Pump INFLATING TIMES*	
TWIN	2 Minutes
QUEEN	3½ Minutes

\* INFLATING TIME VARIES BY DESIRED FIRMNESS

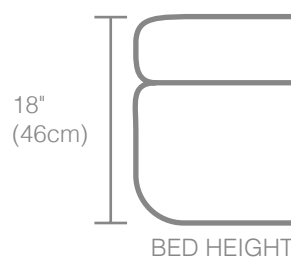
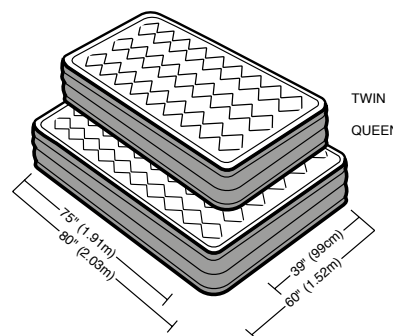

### AIRBED

with Built-in Electric Pump

		Approximate Inflated Size	Built-in Pump	Case Pack	Case Weight
64455E	Twin	39" x 75" x 18"	110 - 120V	2 ea	29.0 lb (13.2 kg)
64456		(99cm x 1.91m x 46cm)	220 - 240V		
64457E	Queen	60" x 80" x 18"	110 - 120V	2 ea	40.3 lb (18.3 kg)
64458		(1.52m x 2.03m x 46cm)	220 - 240V		

Here's an airbed that is sure to impress your most important guests: The Ultra Plush Bed is newly redesigned with revolutionary Fiber-Tech™ Technology. This raised bed combines comfort, convenience, and great appearance into one luxurious airbed, with its unique textured sleeping surface and inflated outer perimeter band for superior stability, comfort and support.

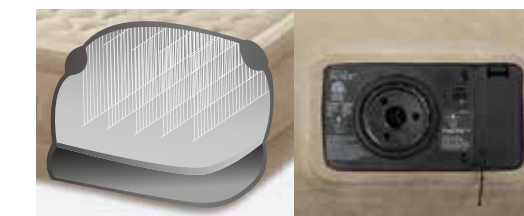

Fiber-Tech™ Technology

Built-in AC Electric Pump



new!

# DURA-BEAM® SERIES SUPREME AIR-FLOW BED

WITH FIBER-TECH™ TECHNOLOGY



## ELEVATED WITH BUILT-IN ELECTRIC PUMP

- Fiber-Tech™ Technology
- 20" (51cm) Raised height
- Plush Velvetaire™ pillow top mattress surface
- Inflated bed fits standard sheets
- Network of inter-connected air pockets that allow air to flow smoothly and gradually across the top and side surfaces



AC Electric Pump INFLATING TIMES*	
TWIN	2½ Minutes
QUEEN	4 Minutes

\* INFLATING TIME VARIES BY MATTRESS SIZE AND DESIRED FIRMNESS

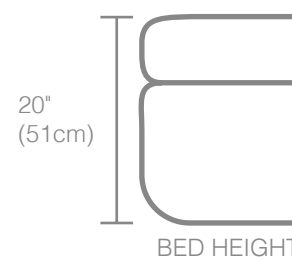
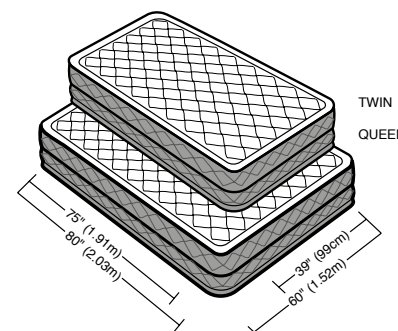

AIRBED with Built-in Electric Pump		Approximate Inflated Size	Built-in Pump	Case Pack	Case Weight
64461E	Twin	39" x 75" x 20" (99cm x 1.91m x 51cm)	110 - 120V 220 - 240V	1 ea	26.0 lb (11.8 kg)
64462					
64463E	Queen	60" x 80" x 20" (1.52m x 2.03m x 51cm)	110 - 120V 220 - 240V	1 ea	36.2 lb (16.5 kg)
64464					

Our Supreme Air-Flow Bed is engineered to provide the ultimate in comfort with the look and feel of a real high end bed. A network for inter-connected air pockets on the top and sides of the bed cause the air to flow smoothly and gradually across the sleeping surface for unbelievable comfort and stability. Constructed with innovative Fiber-Tech™ Technology, this mattress is firmer and more durable than ever before. The dual chamber construction provides firm support and allows for fitted sheets to tuck in easily. Topped with super soft Veletaire™ flocking this bed rivals any traditional mattress in comfort and stability.



Double-Layer Beam Construction  
U.S. Patent No. 7,636,970

Built-in AC Electric Pump

new!

DURA-BEAM® SERIES  
FOAM TOP BED  
WITH FIBER-TECH™ TECHNOLOGY



ELEVATED WITH BUILT-IN  
ELECTRIC PUMP

- Fiber-Tech™ Technology
- Foam Top Layer
- 20" (51cm) Raised height
- Plush Velvetaire™ Flocked mattress surface



CARRY BAG



SHELF BOX



BUILT-IN AIR PUMP

<b>AC</b> Electric Pump INFLATING TIMES*	
QUEEN	3½ Minutes

\* INFLATING TIME VARIES BY DESIRED FIRMNESS

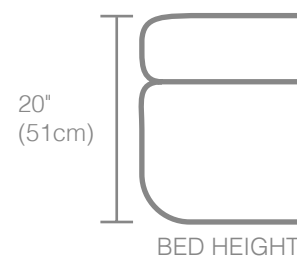
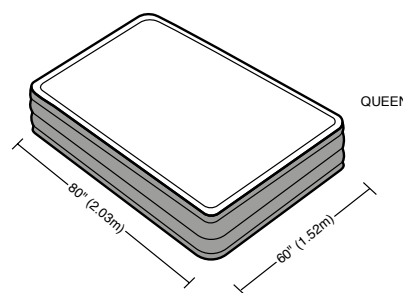

**AIRBED**

with Built-in Electric Pump

		Approximate Inflated Size	Built-in Pump	Case Pack	Case Weight
64467E	Queen	60" x 80" x 20"	110 - 120V	1 ea	24.8 lb (11.3 kg)
64468		(1.52m x 2.03m x 51cm)	220 - 240V		

Guests will enjoy a luxurious night's sleep with the cozy Foam Top High-Rise Airbed. The soft Plush Velvetaire™ flocking surface and foam top layer comfortably contours the body for a rejuvenating sleeping experience. Made with the innovative Fiber-Tech™ Technology, this mattress is firmer and more durable than ever before. Raised edges provide stability and added support while the indented sides ensure your standard queen fitted sheets tuck in easily and securely.

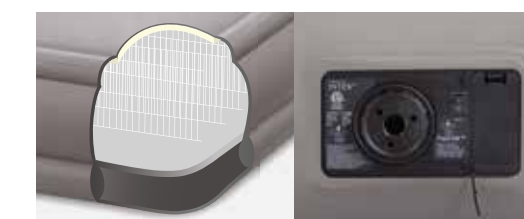

Fiber-Tech™ Technology

Built-in AC Electric Pump

new!

# DURA-BEAM® SERIES HEADBOARD BED

WITH FIBER-TECH™ TECHNOLOGY



## ELEVATED WITH BUILT-IN ELECTRIC PUMP

- Fiber-Tech™ interior construction
- Headboard keeps your pillows from falling off the bed throughout the night, and provides support when sitting up
- 18" (46cm) height provides easier access onto and off of the bed
- Vinyl puncture resistant sides add durability
- Pillow top surface delivers exceptional comfort



<b>AC</b> Electric Pump INFLATING TIMES*	
QUEEN	4½ Minutes

\* INFLATING TIME VARIES BY DESIRED FIRMNESS

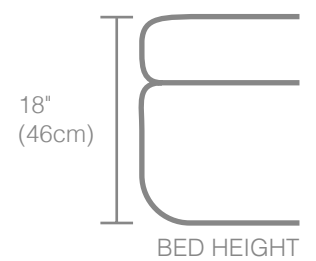
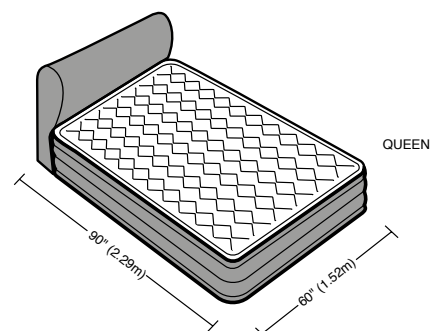

<b>AIRBED</b> with Built-in Electric Pump		Approximate Inflated Size	Built-in Pump	Case Pack	Case Weight
64459E	Queen	60" x 90" x 31" (1.52m x 2.29m x 79cm)	110 - 120V 220 - 240V	1 ea	24.9 lb (11.3 kg)
64460					

Get a quality night's sleep with the new Dura-Beam® Series Headboard Bed. The built-in headboard is versatile. It can be used as an ideal back support when lounging or watching T.V. and as a pillow stopper when sleeping, keeping your pillows from falling on the floor. The pillow top surface gives a cushioned feel for maximum comfort.

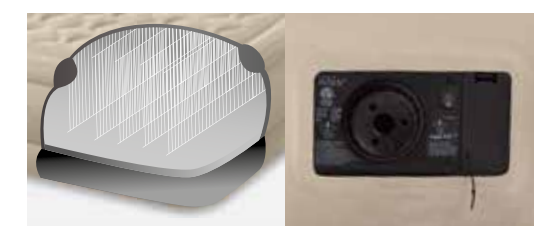

Fiber-Tech™ Technology      Built-in AC Electric Pump

# REDEFINING THE AIRBED

## INTRODUCING

# PremAire®

Elevated Series  
with Fiber-Tech™ Technology

Intex is proud to bring you a new level of luxury and innovation with the latest edition to our unrivaled airbed line, the PremAire® Elevated Series with Fiber-Tech™ Technology.

Built with our patented Fiber-Tech™ Technology, our PremAire® beds offer superb structural stability and support. The high-strength fibers provide an interior with amazing durability and unmatched comfort. The exterior of the mattress is made of laminated PVC to provide a high quality puncture resistant surface. Each mattress is covered in a pillow top that creates air pockets that cause air to flow smoothly and gradually across the surface for an unparalleled sleeping experience.

The bed's elevated height makes it easier to get in and out of each morning. For extra convenience, this bed comes with a powerful built-in electric pump for fast inflation and deflation. Our new revolutionary PremAire® mattress offers the perfect combination of luxurious comfort and best-in-class durability.

# INTEX®

INTEX®

# PremAire®

WITH FIBERTECH™ TECHNOLOGY

## THE MOST ADVANCED AIRBED TECHNOLOGY

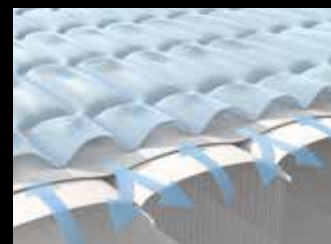

### LUXURIOUS PILLOW TOP

Hundreds of inter-connected air pockets engineered so that air flows gently across the sleeping surface creating body-hugging comfort

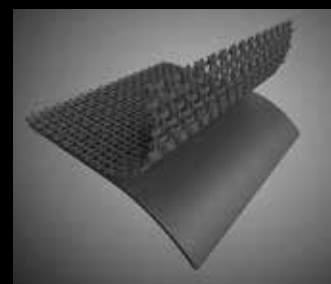

### HEAVY DUTY 2-PLY MATERIAL

The 2-ply laminated side walls and bottom firmly retain air while providing a high quality puncture-resistant surface



**18" (46cm) BED HEIGHT**



### 100% QUALITY TESTED

100% of our airbeds are quality tested to be air tight before they leave our factory

### POWERFUL BUILT-IN AIR PUMP

Powerful built-in electric pump for fast inflation and deflation

### QUALITY ASSURED



Peace of mind 1 year warranty

### NEWLY REDESIGNED CARRY BAG

New stylish carry bag for easy storage and transport

U.S. Patent No. 8,562,773

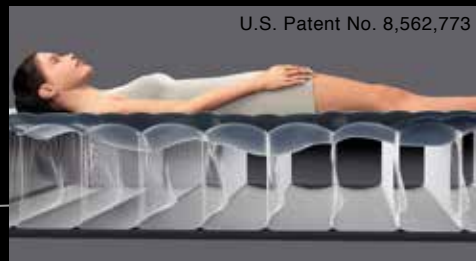

### REVOLUTIONARY FIBER-TECH™ TECHNOLOGY

Revolutionary, patented Fiber-Tech™ support system provides the perfect combination of superb structural stability and support

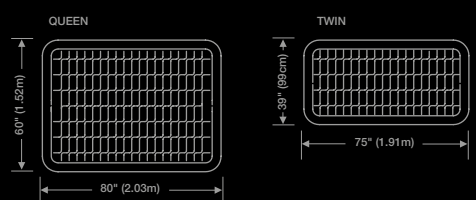

## THE PERFECT COMBINATION OF COMFORT AND SUPPORT



Item	Size	Approximate Inflated Size	Built-in Pump	Case Pack	Case Weight
64471E 64472	Twin	39" x 75" x 18" (99cm x 1.91m x 46cm)	110-120V 220-240V	2 ea	32.8 lb (14.9 kg)
64473E 64474	Queen	60" x 80" x 18" (1.52m x 2.03m x 46cm)	110-120V 220-240V	1 ea	23.5 lb (10.7 kg)

### INFLATING TIMES\*

#### AC Electric Pump

Twin	2½ minutes
Queen	4 minutes

\*Inflating time varies by mattress size and desired firmness

# CAMPING

## Enjoy the Great Outdoors

Intex knows that disconnecting from the pace of modern life doesn't mean giving up comfort. Intex Camping Airbeds have all been specifically designed to provide an uncompromising level of style, durability, comfort, and ease. Intex Camping Airbeds come in a variety of shapes, sizes, and styles to suit nearly any outdoor adventure.

new!

## COT SIZE CAMP BED

Find your perfect sleep solution for the outdoors with the new Cot Size Camp Bed. Made with rugged laminated PVC. This bed is designed to fit easily on cots or inside tents. This lightweight and portable mat provides a smooth and comfortable sleeping surface in any outdoor environment.



SHELF BOX



FOLDS COMPACTLY

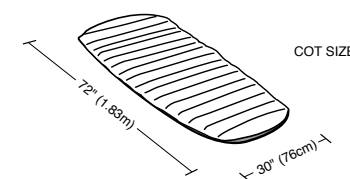

### CAMPING

Bed		Approximate Inflated Size	Case Pack	Case Weight
68708 / E	Cot Size	30" x 72" x 4" (76cm x 1.83m x 10cm)	6 ea	26.8 lb (12.2 kg)



# SUPER-TOUGH™ AIRBED

Bright, bold and compact, the Super-Tough™ airbed provides campers with the ultimate camping experience.

The Super-Tough™ PVC and polyester laminate create a smooth, yet strong sleeping surface, guaranteed to give campers a great night's sleep. High-strength Fiber-Tech™ fibers make up the inner construction and are combined with a puncture resistant laminated surface to make this camping airbed very strong, comfortable, and long-lasting.

For the ultimate in convenience, the Super-Tough™ bed is also available with a built-in 6 C-cell battery pump.



## STRENGTH, LIGHT-WEIGHT, CONVENIENCE & COMFORT

- Fiber-Tech™ interior construction
- Bright and bold outdoor color
- Super-Tough™ laminated exterior surfaces

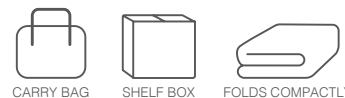

CARRY BAG SHELF BOX FOLDS COMPACTLY

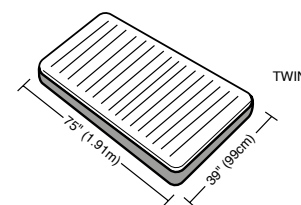

### AIRBED

with Built-in 6 C-Cell Battery Pump

Approximate Inflated Size	Case Pack	Case Weight
39" x 75" x 8" (99cm x 1.91m x 20cm)	3 ea	24.6 lb (11.2 kg)



Fiber-Tech™ Technology

Perfect for camping with 6 C-cell batteries (not included)

# ROLL 'N GO™ BED

The Roll 'N Go™ bed offers the perfect ultra light weight sleep solution for your next camping trip.

## ULTIMATE OUTDOOR BED WITH PUMP

- Fiber-Tech™ interior construction
- Eco-friendly TPU laminated fabric – phthalate-free material
- Hand-held high output lightweight manual air pump
- Duffel bag with handle included



SHELF BOX FOLDS COMPACTLY

This PVC Free airbed is constructed of laminated TPU, which means it is:

- Super Tough – Softens up the rough outdoors with a very durable, eco-friendly material
- Strong Support System – Inflates up to three times the pressure of a regular PVC junior-twin airbed for a firmer sleeping surface
- Ultra Lightweight – Weighs approximately one fourth less than a common junior-twin PVC constructed airbed

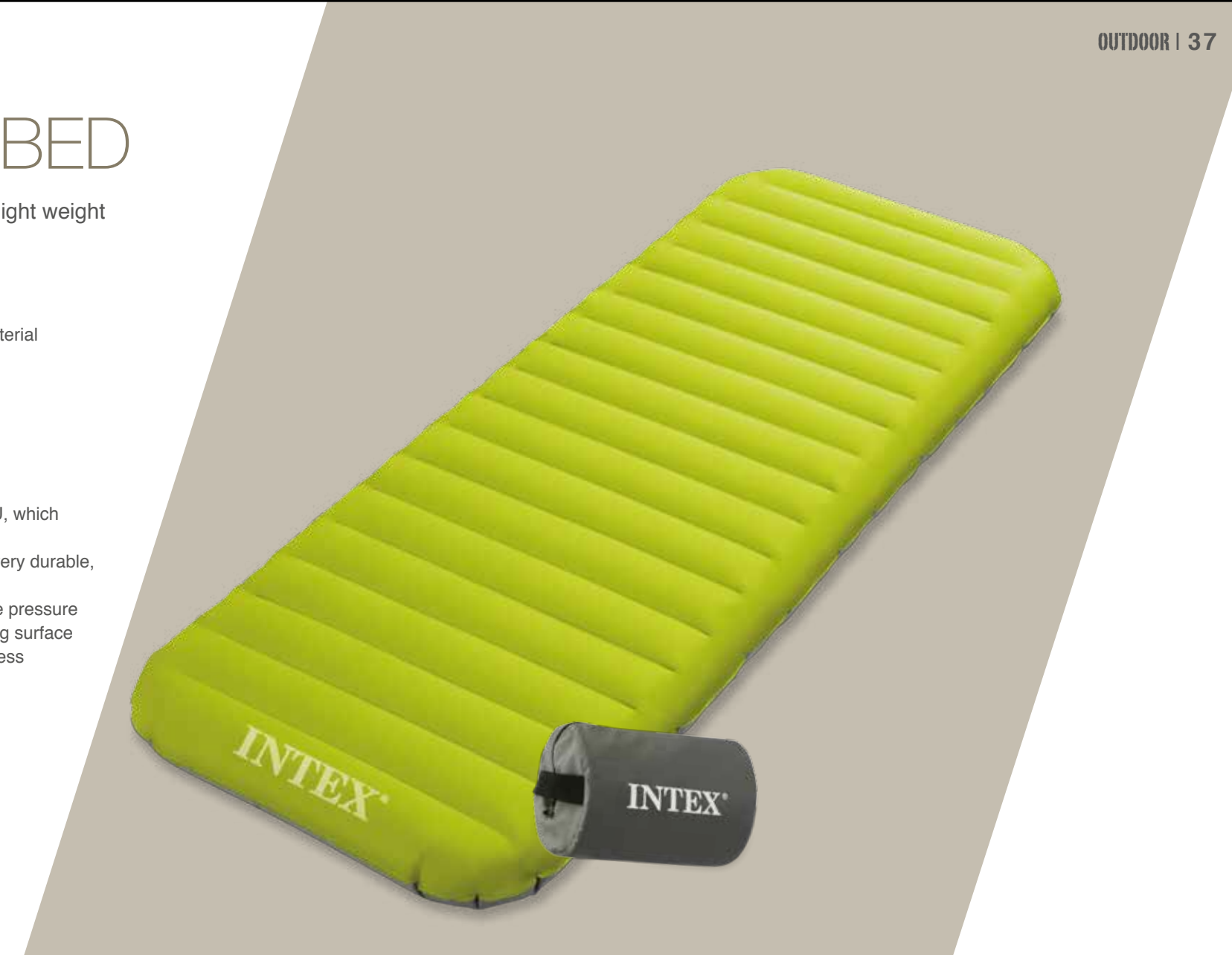

## MAXIMUM DURABILITY

The strong TPU (Thermoplastic Polyurethane) laminated material and innovative Fiber-Tech™ inner construction transform the toughest ground into a refreshing night's sleep. It retains elasticity in temperature as low as -4° F/-20° C.

Made of TPU – A PVC-free eco-friendly material

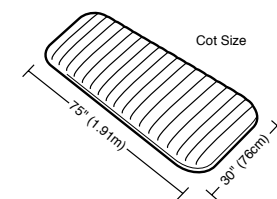

### AIRBED

with Hand Pump

Approximate Inflated Size	Hand Pump	Case Pack	Case Weight
30" x 75" x 5" (76cm x 1.91m x 13cm)	68612	4 ea	20.9 lb (9.5 kg)



Fiber-Tech™ Technology

Hand Pump (#68612)

# CAMPING MATS

A quick, simple and lightweight sleeping solution while camping. Wave beam construction for a uniform sleeping surface. Intex camping mats provide comfort and durability for outside conditions.

## LAMINATED FABRIC TOPS FOR DURABILITY

- Laminated vinyl to withstand the elements
- Each mat has a unique construction that helps provide more comfort to campers
- Topped with fabric to ensure sleeping comfort



SHELF BOX FOLDS COMPACTLY

#68797



#68799



#68798

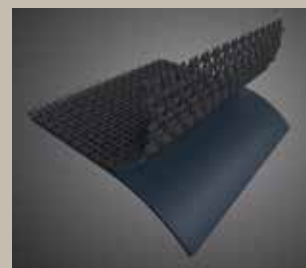

Puncture-resistant 2-ply laminate

## CAMPING

Mat	Approximate Inflated Size	Case Pack	Case Weight
68797 / E	26½" x 72½" x 6¾" (67cm x 1.84m x 17cm)	6 ea	19.1 lb (8.7 kg)
68798 / E	28½" x 74½" x 8" (72cm x 1.89m x 20cm)	6 ea	26.0 lb (11.8 kg)
68799 / E	50" x 76" x 9½" (1.27m x 1.93m x 24cm)	3 ea	22.6 lb (10.3 kg)

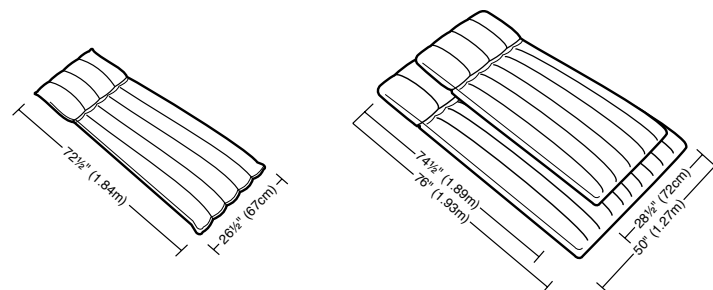

# DOWNY BED

This airbed has a flocked top that provides a more comfortable sleeping surface. Its unique wave beam construction eliminates uncomfortable surface bumps and provides a flat, uniform sleeping surface. The Downy airbed can be inflated with either the built-in manual foot pump or a regular pump.

## BUILT-IN FOOT PUMP FOR CONVENIENCE

- Unique built-in bellow foot pump for convenience-no separate pump needed. Just step down to inflate and the pump springs back automatically for the next cycle
- New and improved foot pump construction allows for faster inflation
- 2-in-1 valve for inflating with optional electric or manual pumps
- Conventional mattress sizes (L x W) for more sleeping area and a better fit for sheets
- 8¾" (22cm) mattress thickness for extra soft comfort



SHELF BOX FOLDS COMPACTLY

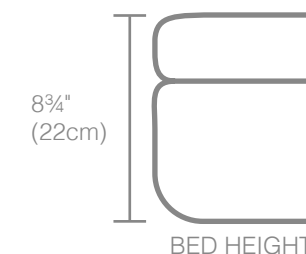

8¾"  
(22cm)

BED HEIGHT

INFLATING TIMES*	
COT SIZE	2 Minutes
TWIN	3 Minutes
FULL	3 Minutes
QUEEN	4 Minutes

\*INFLATING TIME VARIES BY MATTRESS SIZE AND DESIRED FIRMNESS

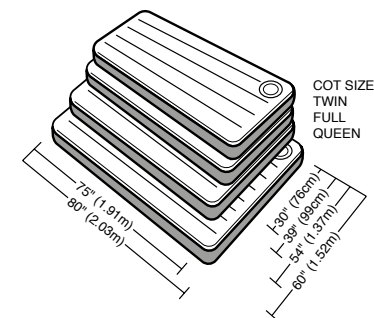

COT SIZE  
TWIN  
FULL  
QUEEN

## AIRBED

with Built-in Foot Pump	Approximate Inflated Size	Case Pack	Case Weight
66950 / E Cot Size	30" x 75" x 8¾" (76cm x 1.91m x 22cm)	6 ea	36.4 lb (16.6 kg)
66927 / E Twin	39" x 75" x 8¾" (99cm x 1.91m x 22cm)	4 ea	29.8 lb (13.5 kg)
66928 / E Full	54" x 75" x 8¾" (1.37m x 1.91m x 22cm)	3 ea	28.3 lb (12.9 kg)
66929 / E Queen	60" x 80" x 8¾" (1.52m x 2.03m x 22cm)	3 ea	32.3 lb (14.7 kg)



Wave Beam Construction

Built-in lightweight foot pump for easy inflation - No separate pump or power supply needed!



# PRESTIGE DOWNY BED



INFLATING TIMES*	
TWIN	2 Minutes
FULL	2 Minutes
QUEEN	2 1/2 Minutes

\*INFLATING TIME VARIES BY MATTRESS SIZE AND DESIRED FIRMNESS



Wave Beam Construction For home or camping Operates on 6 C-cell batteries (not included) The perfect camping companion

The perfect choice for the rugged outdoors. The flocked top provides a comfortable sleeping surface, and is easy to clean. The powerful battery-operated (6 x C-cell) pump goes anywhere!

### WITH HAND-HELD BATTERY PUMP

- 3-in-1 valve has extra-wide openings for fast inflating and deflating
- Conventional mattress sizes (L x W) for more sleeping area and a better fit for sheets
- Battery pump can also be used on other inflatables
- 8 3/4" (22cm) mattress thickness for extra soft comfort

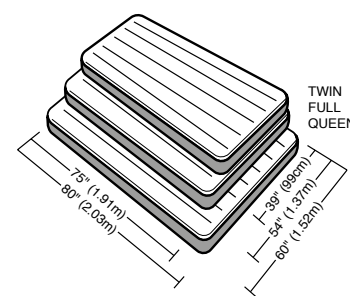

AIRBED with Handheld 6 C-Cell Battery Pump		Approximate Inflated Size	Case Pack	Case Weight
66967 / E	Twin	39" x 75" x 8 3/4" (99cm x 1.91m x 22cm)	4 ea	30.4 lb (13.8 kg)
66968 / E	Full	54" x 75" x 8 3/4" (1.37m x 1.91m x 22cm)	3 ea	29.0 lb (13.2 kg)
66969 / E	Queen	60" x 80" x 8 3/4" (1.52m x 2.03m x 22cm)	3 ea	33.4 lb (15.2 kg)

# CLASSIC DOWNY BED

For indoor and outdoor use.

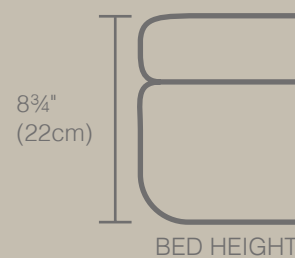
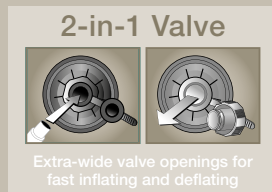

INFLATING TIMES*	
QUEEN	5 Minutes

\*INFLATING TIME VARIES BY MATTRESS SIZE AND DESIRED FIRMNESS



Wave Beam Construction

Airbed Set (#68765/E)

You can't go wrong with this bed! Take it camping or use it for out of town guests. Our best selling Classic Downy Bed is versatile and perfect for both in-home and camping. The wave beam construction creates a uniform sleeping surface that is guaranteed to give you a good night's rest wherever you are. Plush flocking provides a luxurious sleeping surface while keeping sheets in place. It's also easy to clean and waterproofed for camping use. The Classic Downy Bed offers retailers and consumers the best value for their money at an opening price point.

### PLUSH FLOCKED TOP FOR COMFORT

- 2-in-1 valve has extra-wide openings for fast inflating and deflating
- Conventional mattress sizes (L x W) for more sleeping area and a better fit for sheets
- 8 3/4" (22cm) mattress thickness for extra soft comfort



## AIRBED only

		Approximate Inflated Size	Case Pack	Case Weight
68950 / E	Cot Size	30" x 75" x 8 3/4" (76cm x 1.91m x 22cm)	6 ea	31.2 lb (14.2 kg)
68757 / E	Twin	39" x 75" x 8 3/4" (99cm x 1.91m x 22cm)	4 ea	26.1 lb (11.9 kg)
68758 / E	Full	54" x 75" x 8 3/4" (1.37m x 1.91m x 22cm)	3 ea	25.9 lb (11.8 kg)
68759 / E	Queen	60" x 80" x 8 3/4" (1.52m x 2.03m x 22cm)	3 ea	30.6 lb (13.9 kg)
68755 / E	King	72" x 80" x 8 3/4" (1.83m x 2.03m x 22cm)	2 ea	23.9 lb (10.9 kg)

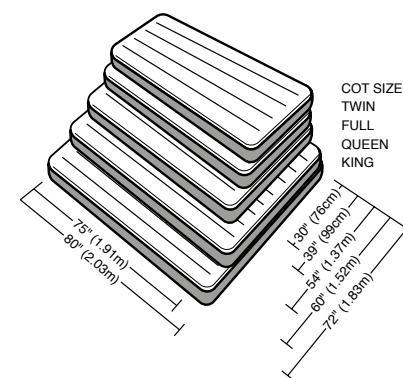

## AIRBED SET

Includes two I-beam pillows  
17" x 11" x 3 1/2" (43cm x 28cm x 9cm)  
and a #68612 Double-Quick air pump

		Approximate Inflated Size	Hand Pump	Case Pack	Case Weight
68765 / E	Queen	60" x 80" x 8 3/4" (1.52m x 2.03m x 22cm)	68612	3 ea	35.0 lb (15.9 kg)

# PILLOW REST CLASSIC BED

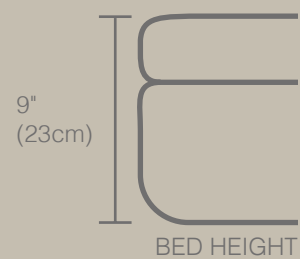

AC Electric Pump INFLATING TIMES*	
TWIN	1 Minute
FULL	1 1/2 Minutes
QUEEN	1 3/4 Minutes

\*INFLATING TIME VARIES BY MATTRESS SIZE AND DESIRED FIRMNESS

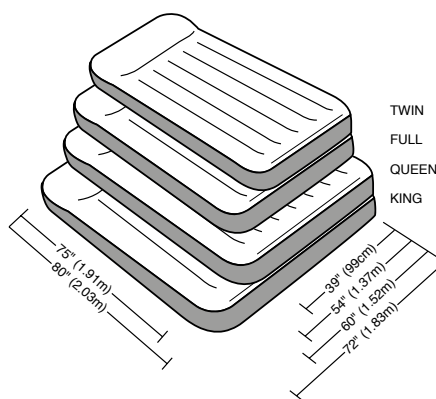

## AIRBED

only	Approximate Inflated Size	Case Pack	Case Weight
66767 / E Twin	39" x 75" x 9" (99cm x 1.91m x 23cm)	4 ea	29.9 lb (13.6 kg)
66768 / E Full	54" x 75" x 9" (1.37m x 1.91m x 23cm)	3 ea	29.9 lb (13.6 kg)
66769 / E Queen	60" x 80" x 9" (1.52m x 2.03m x 23cm)	3 ea	35.2 lb (16.0 kg)
66770 / E King	72" x 80" x 9" (1.83m x 2.03m x 23cm)	2 ea	27.9 lb (12.7 kg)

## AIRBED

with Built-in Electric Pump	Approximate Inflated Size	Built-in Pump	Case Pack	Case Weight
66775E Twin 66779	39" x 75" x 9" (99cm x 1.91m x 23cm)	110 - 120V 220 - 240V	4 ea	37.9 lb (17.2 kg)
66776E Full 66780	54" x 75" x 9" (1.52m x 1.91m x 23cm)	110 - 120V 220 - 240V	3 ea	36.1 lb (16.4 kg)
66777E Queen 66781	60" x 80" x 9" (1.52m x 2.03m x 23cm)	110 - 120V 220 - 240V	3 ea	42.1 lb (19.2 kg)



Wave Beam Construction

Built-in AC Electric Pump

Built-in pillow for added convenience

For those who need a pillow but lack the space to carry one, this luxurious flocked bed is the answer. The waterproof and stain resistant surface makes it easy to keep clean while providing the soft comfort of home.

### BUILT-IN COMFORT

- Flocked sleeping surface for extra comfort
- A built-in pillow provides bed-like comfort
- Mattress is raised 9" (23cm) from the floor for convenience
- 3-in-1 valve on "Airbed Only" series has extra-wide openings
- Inflated dimensions fit standard sheet sizes



CARRY BAG SHELF BOX FOLDS COMPACTLY BUILT IN AIR PUMP





## AIR FURNITURE

### Style. Color. Fun. Cool Living Spaces with Intex.

Intex brings to you an exciting and vibrant line of air furniture for any age, any setting and any season! With great colors and design, whether for the indoors or the outdoors, Intex has something for everyone. Decorate your room with Intex!





## BEANLESS BAG™ CHAIR ASSORTMENT

A great bean bag without the hassle of bean bag inserts and slipcovers. Just unfold and inflate, and in minutes you have a super soft bean bag that is perfect for lounging, studying, or watching movies. Vivid colors will brighten up any room. Comes in an assortment of three bright and vivid colors: Magenta Pink, Lime Green, or Lilac Purple.

### PERFECTLY PORTABLE BEANLESS BAG™

- Available in magenta pink, lime green and lilac purple
- Folds compactly for storage
- Shelf box

Item	Approximate Inflated Size	Case Pack	Case Weight
68569NP / EP	42" x 41" x 27" (1.07m x 1.04m x 69cm)	6 ea, asst	33.2 lb (15.1 kg)



U.S. Patent No. 6,152,530

new!

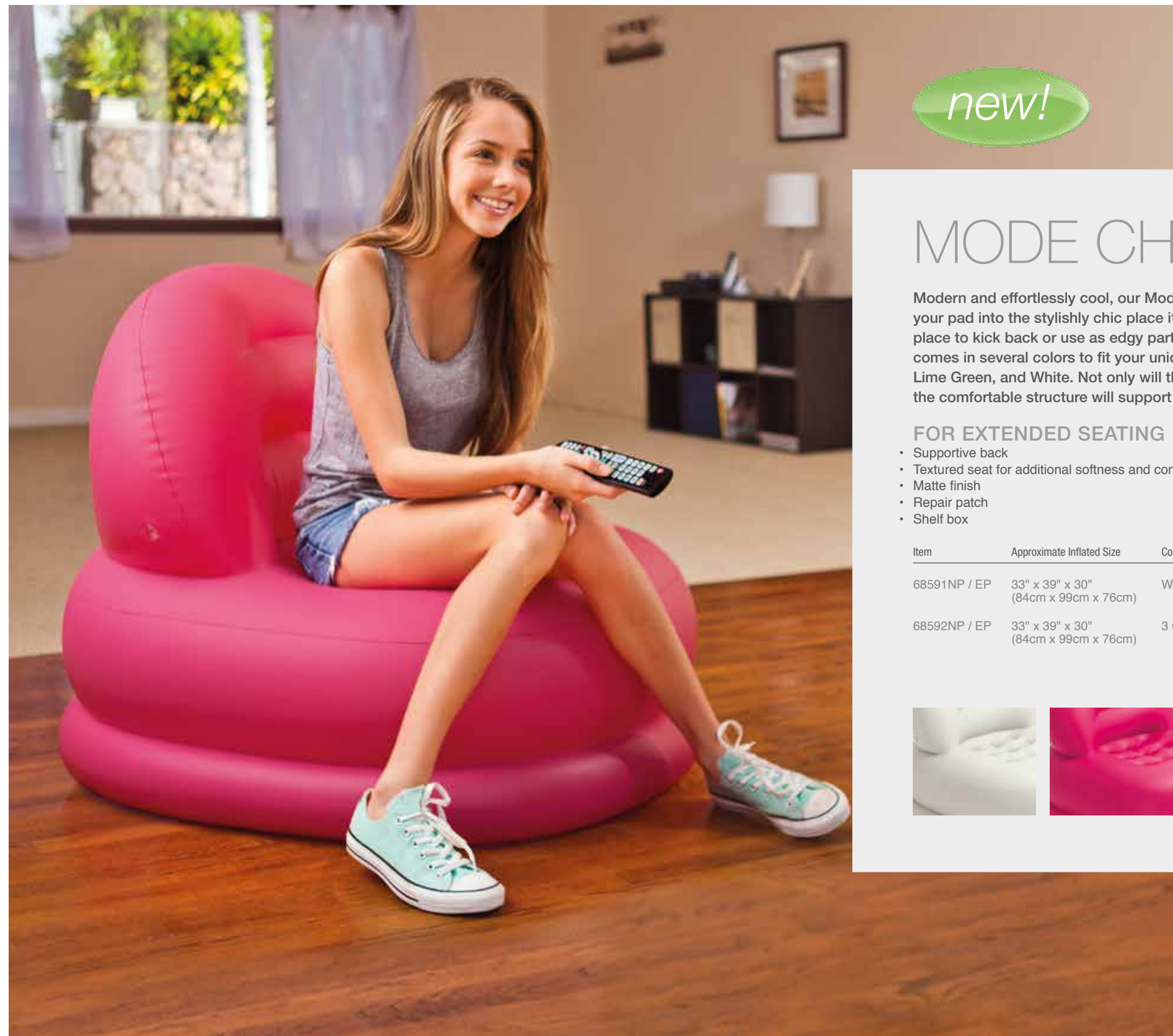

## MODE CHAIR

Modern and effortlessly cool, our Mode Chair is a surefire way to turn your pad into the stylishly chic place it deserves to be. It's the best place to kick back or use as edgy party decor. The innovative design comes in several colors to fit your unique style including Magenta Pink, Lime Green, and White. Not only will the colors support your style but the comfortable structure will support you, in style.

### FOR EXTENDED SEATING

- Supportive back
- Textured seat for additional softness and contoured fit
- Matte finish
- Repair patch
- Shelf box

Item	Approximate Inflated Size	Color	Case Pack	Case Weight
68591NP / EP	33" x 39" x 30" (84cm x 99cm x 76cm)	White	6 ea	28.2 lb (12.8 kg)
68592NP / EP	33" x 39" x 30" (84cm x 99cm x 76cm)	3 Colors	6 ea, asst	28.2 lb (12.8 kg)

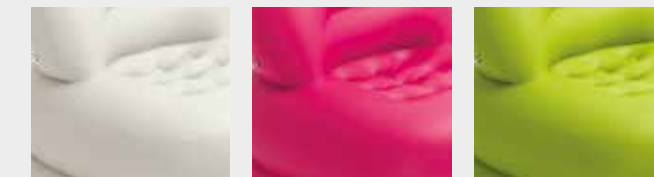

 new!

## COSMO CHAIR

The Cosmo Chair will style up a room with ease and bring new excitement to your life. The Cosmo Chair provides cool comfort at home, spicing up any room with its contemporary design that looks and feels stylish. The sleek shiny style is the most modern way to chill out, and colors like Magenta Pink, Lime Green and Aqua Blue are perfect to fit your unique taste!

### AN INVITING SPLASH OF COLOR AND COMFORT

- Oversize seat for extra comfort
- Transparent with a glossy finish
- Repair patch
- Shelf box

Item	Approximate Inflated Size	Color	Case Pack	Case Weight
68593NP / EP	41" x 46" x 27" (1.04m x 1.17m x 69cm)	Blue	3 ea	18.7 lb (8.5 kg)
68594NP / EP	41" x 46" x 27" (1.04m x 1.17m x 69cm)	3 Colors	3 ea, asst	18.7 lb (8.5 kg)



## CAFÉ CHAISE CHAIR

Stunning and eye-catching, this Café Chaise Chair adds flair to any room! Paired with an ottoman, the advanced structural design provides an exceptionally comfortable seat regardless of your height.

### COLORFUL CUSHY LUXURY

- Combo valve has extra-wide openings for fast inflating and deflating
- Available in lilac purple, sky blue, and sunny orange
- Folds compactly for storage
- Shelf box

Item	Approximate Inflated Size	Case Pack	Case Weight
68572NP / EP Chair	41" x 43" x 28" (1.04m x 1.09m x 71cm)	3 ea, asst	20.9 lb (9.5 kg)
Ottoman	25" x 11" (64cm x 28cm)		





## BEANLESS BAG™ CHAIR

Intex completes the Beanless Bag™ Chair line with the introduction of a warm, neutral color combined with our revolutionary corduroy texture flocking! Its elegant and luxurious look and feel will add a new dimension to any room!

### PERFECTLY PORTABLE BEANLESS BAG™

- Folds compactly for storage
- Shelf box

Item	Approximate Inflated Size	Case Pack	Case Weight
68579NP / EP	42" x 41" x 27" (1.07m x 1.04m x 69cm)	6 ea	34.1 lb (15.5 kg)

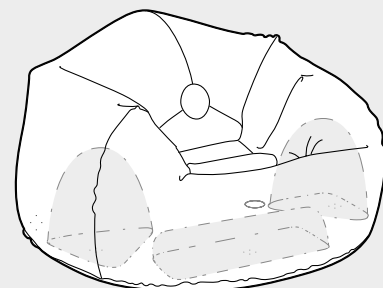

Beanless Bag™ chair inner structure  
U.S. Patent No. 6,152,530



## ULTRA LOUNGE

Attractive contours from any angle, the beauty of this lounge chair is matched only by its comfort. Contact surfaces on the top and sides are lined with flocking for the touch of luxury. The side cup holder is just as indispensable here as in your favorite sports car.

### RELAX AT HOME WITH OUR ULTRA LOUNGE

- 2-in-1 valve has extra-wide openings for fast inflating and deflating
- Convenient cup holder for refreshments
- Folds compactly for storage
- Shelf box

Item	Approximate Inflated Size	Case Pack	Case Weight
68564NP / EP Chair	39" x 51" x 30" (99cm x 1.30m x 76cm)	4 ea	31.5 lb (14.3 kg)
Ottoman	25" x 11" (64cm x 28cm)		



Comfortable seating with side cup holder



*new structure!*

## PULL-OUT CHAIR

A perfect chair that transforms into a single bed! Not only is it comfortable, it's conveniently versatile. Ideal for college dorms, guest bedrooms and even on the road.

### STURDY COMFORT

- 2-in-1 valve has extra-wide openings for fast inflating and deflating
- Folds compactly for storage
- Shelf box

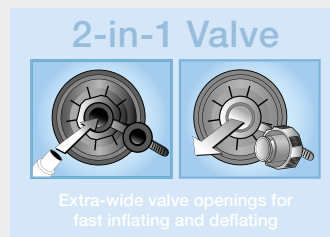

Item	Approximate Inflated Size	Case Pack	Case Weight
68565NP / EP	42" x 87" x 26" (1.07m x 2.21m x 66cm)	2 ea	22.2 lb (10.1 kg)

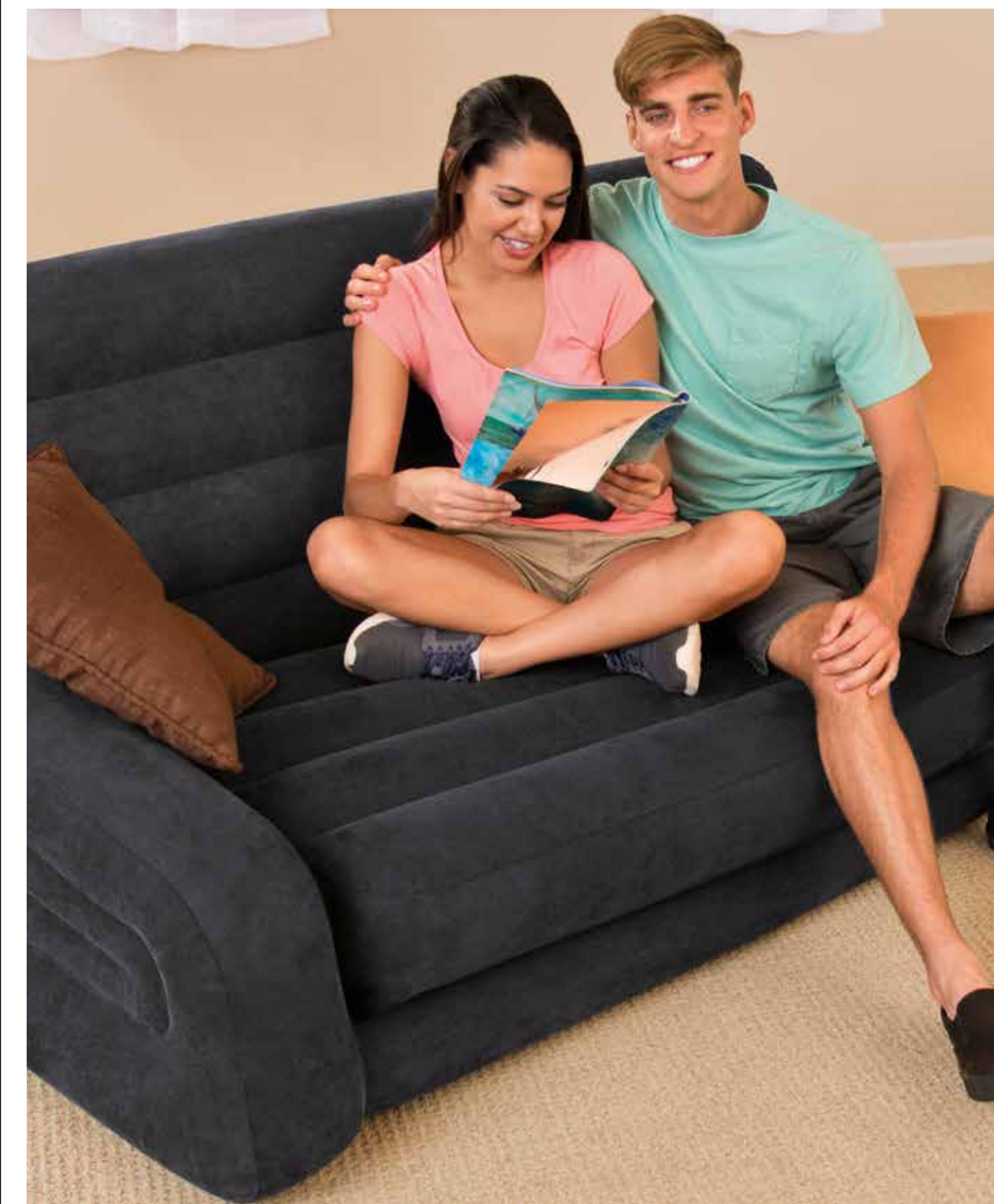

*new structure!*

## PULL-OUT SOFA

A versatile sofa that offers an affordable and comfortable sleeping solution for any home. It is quick and easy to inflate and will seat or sleep two people.

### PRACTICAL & VERSATILE

- 2-in-1 valve has extra-wide openings for fast inflating and deflating
- 3 quick inflation and deflation valves
- Comfortable backrest and armrest
- Folds compactly for storage
- Shelf box

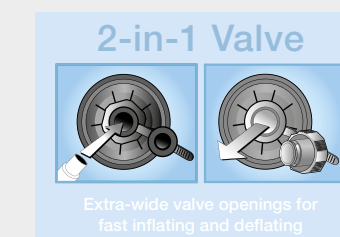

Item	Approximate Inflated Size	Case Pack	Case Weight
68566NP / EP	76" x 87" x 26" (1.93m x 2.21m x 66cm)	2 ea	41.0 lb (18.7 kg)







## EMPIRE CHAIR

Modern, sophisticated and endlessly comfortable best describes this new addition to our line of inflatable chairs. In sunny orange, pink or lime green with an innovative transparent trim, this chair is the perfect combination of form and function. It's ideal for teens, college students and young professionals!

### AN INVITING SPLASH OF COLOR AND COMFORT

- Extra strong laminated bottom for better durability
- Great for both indoors and outdoors
- Shelf box

Item	Approximate Inflated Size	Color	Case Pack	Case Weight
68581NP / EP	44" x 43" x 27" (1.12m x 1.09m x 69cm)	Green	3 ea	21.5 lb (9.8 kg)
68582NP / EP	44" x 43" x 27" (1.12m x 1.09m x 69cm)	3 Colors	3 ea, asst	21.5 lb (9.8 kg)



Puncture-resistant 2-ply reinforced laminated bottom

new!

## MEGA LOUNGE

What makes this a mega lounge? Keeping multi-function in mind, this lounge is designed for the ultimate comfort experience. Its long seat will let you sprawl out when you are gaming or watching TV. The included cup holder lets you keep snacks or a drink at arm's length.

### PERFECT FOR RELAXING AT HOME

- Sleek design for a modern style
- Grooved and contoured shape for a natural fit and added comfort
- Long seat perfect for extending legs
- 1 cup holder
- 2-in-1 valve with extra wide openings for fast inflation and deflation
- Repair patch
- Shelf box

Item	Approximate Inflated Size	Case Pack	Case Weight
68585NP / EP	32" x 68" x 36" (81cm x 1.73m x 91cm)	3 ea	24.5 lb (11.1 kg)



Puncture-resistant 2-ply reinforced laminated bottom



## SPLASH LOUNGE

The Splash Lounge will look gorgeous indoors or outdoors. It's a great casual addition to any room. The reinforced bottom also makes it durable for lounging on the patio, yard or poolside.

### PERFECTLY PORTABLE LOUNGE

- Extra strong laminated bottom for better durability
- Great for both indoors and outdoors
- Shelf box

Item	Approximate Inflated Size	Case Pack	Case Weight
68880NP / EP	33" x 67" x 32" (84cm x 1.70m x 81cm)	3 ea	21.1 lb (9.6 kg)

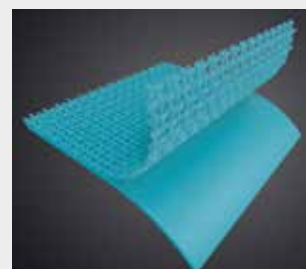

Puncture-resistant 2-ply reinforced laminated bottom



Soft Flocked Surface

## ULTRA DAYBED LOUNGE

The Ultra Daybed Lounge invites you to relax, soak up the sun and hang out with friends. It's an elegant addition to any room, patio or yard as the reinforced bottom and soft flocking make it versatile enough for both indoors and outdoors.

### RELAX AT HOME WITH OUR ULTRA LOUNGE

- Detachable backrest for extra comfort and versatility
- Extra strong laminated bottom for better durability
- Great for both indoors and outdoors
- Quick coupling buckles for the backrest
- Shelf box

Item	Approximate Inflated Size	Case Pack	Case Weight
68881NP / EP	75" (D) x 21" (H) (1.91m x 53cm)	2 ea	35.4 lb (16.1 kg)

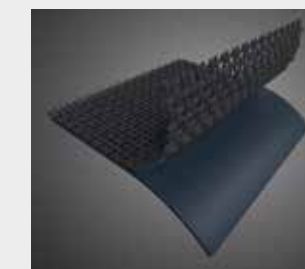

Puncture-resistant 2-ply reinforced laminated bottom





## CORNER SOFA

A corner sofa can be a fantastic addition to any living room. This beautifully designed piece is luxurious yet convenient. Create an intimate conversation area or an expansive seating arrangement for family and friends. Casual and comfortable, this sofa is designed with deep seats and wide armrests, and sleekly streamlined for sophisticated appeal.

### SPACIOUS COMFORT AND CONVENIENCE

- Quality-tested waterproof flocked surface for a luxurious feel
- 2-in-1 valve with extra-wide openings for fast inflating and deflating
- Neutral color to suit any home decor
- Repair patch
- Shelf box

#### 2-in-1 Valve

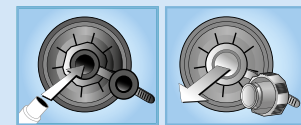

Extra-wide valve openings for fast inflating and deflating

Item	Approximate Inflated Size	Case Pack	Case Weight
68575NP / EP	101" x 80" x 30" (2.57m x 2.03m x 76cm)	1 ea	27.9 lb (12.7 kg)

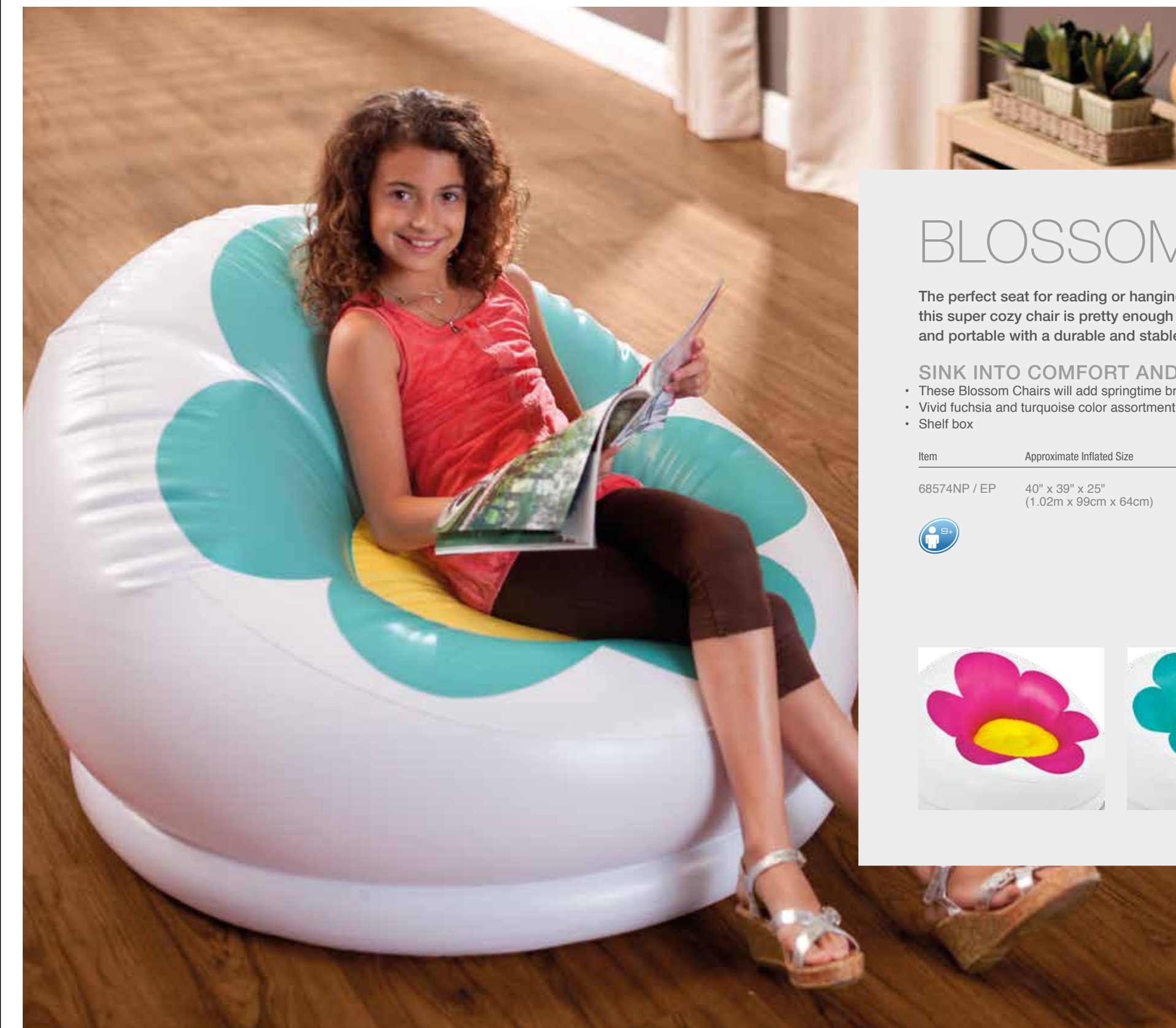

## BLOSSOM CHAIR

The perfect seat for reading or hanging out and chatting with friends, this super cozy chair is pretty enough for any girl's room! It's light and portable with a durable and stable structure.

### SINK INTO COMFORT AND PRETTINESS

- These Blossom Chairs will add springtime brightness to any girl's room
- Vivid fuchsia and turquoise color assortment
- Shelf box

Item	Approximate Inflated Size	Case Pack	Case Weight
68574NP / EP	40" x 39" x 25" (1.02m x 99cm x 64cm)	6 ea, asst	27.1 lb (12.3 kg)



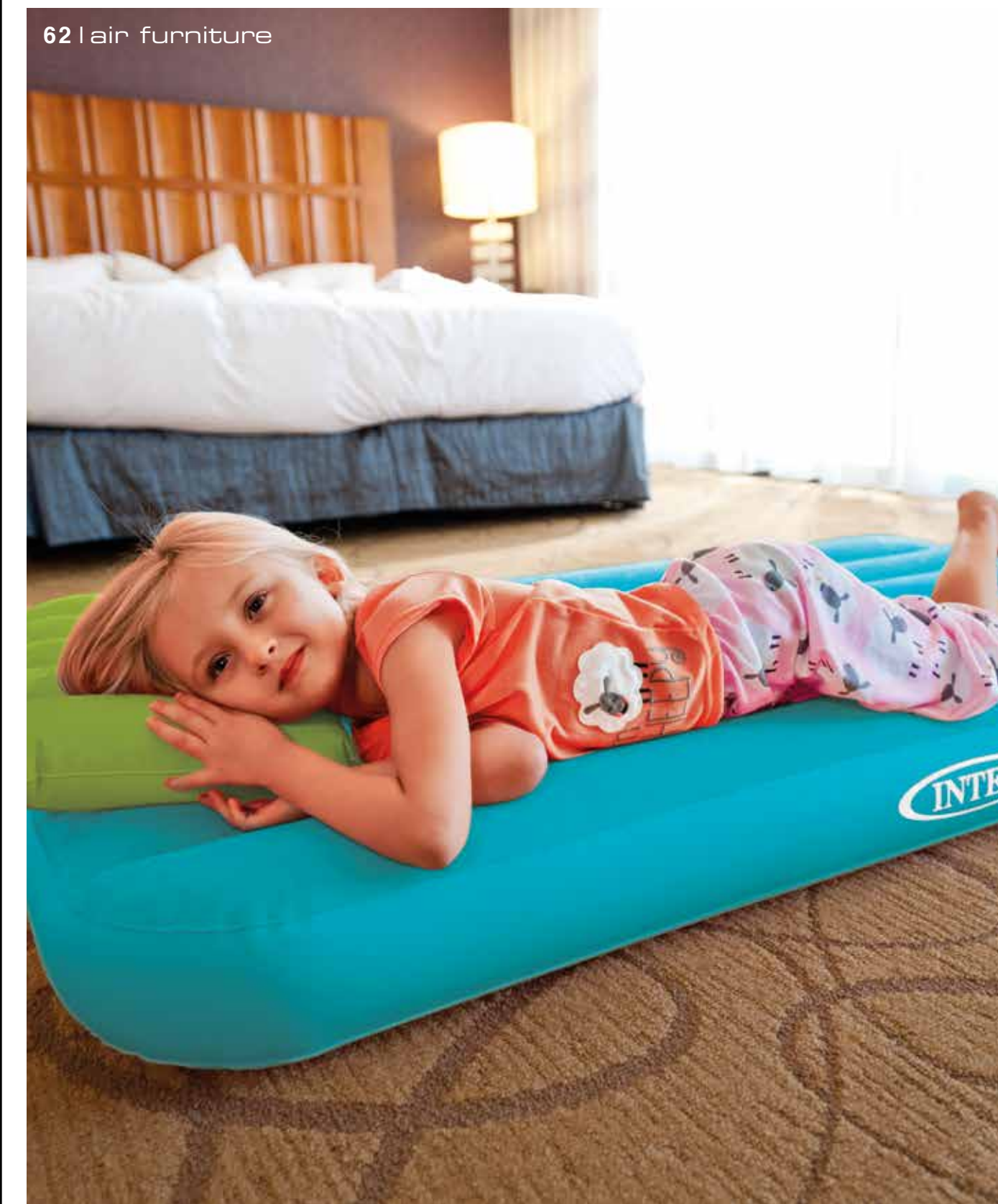

## COZY KIDZ™ AIRBED

The perfect airbed for kids with soft, inflatable pillows in three fun and exciting colors! It will come in handy for sleepovers, nap time and travel, without sacrificing comfort or convenience!

### COZY & FUN

- Assorted bright, fun colors
- Soft flocking for extra comfort
- Includes inflatable flocked pillow
- Repair patch
- Shelf box

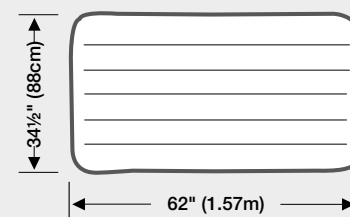

Item	Approximate Inflated Size	Case Pack	Case Weight
66801NP / EP	34½" x 62" x 7" (88cm x 1.57m x 18cm)	6 ea, asst	27.5 lb (12.5 kg)

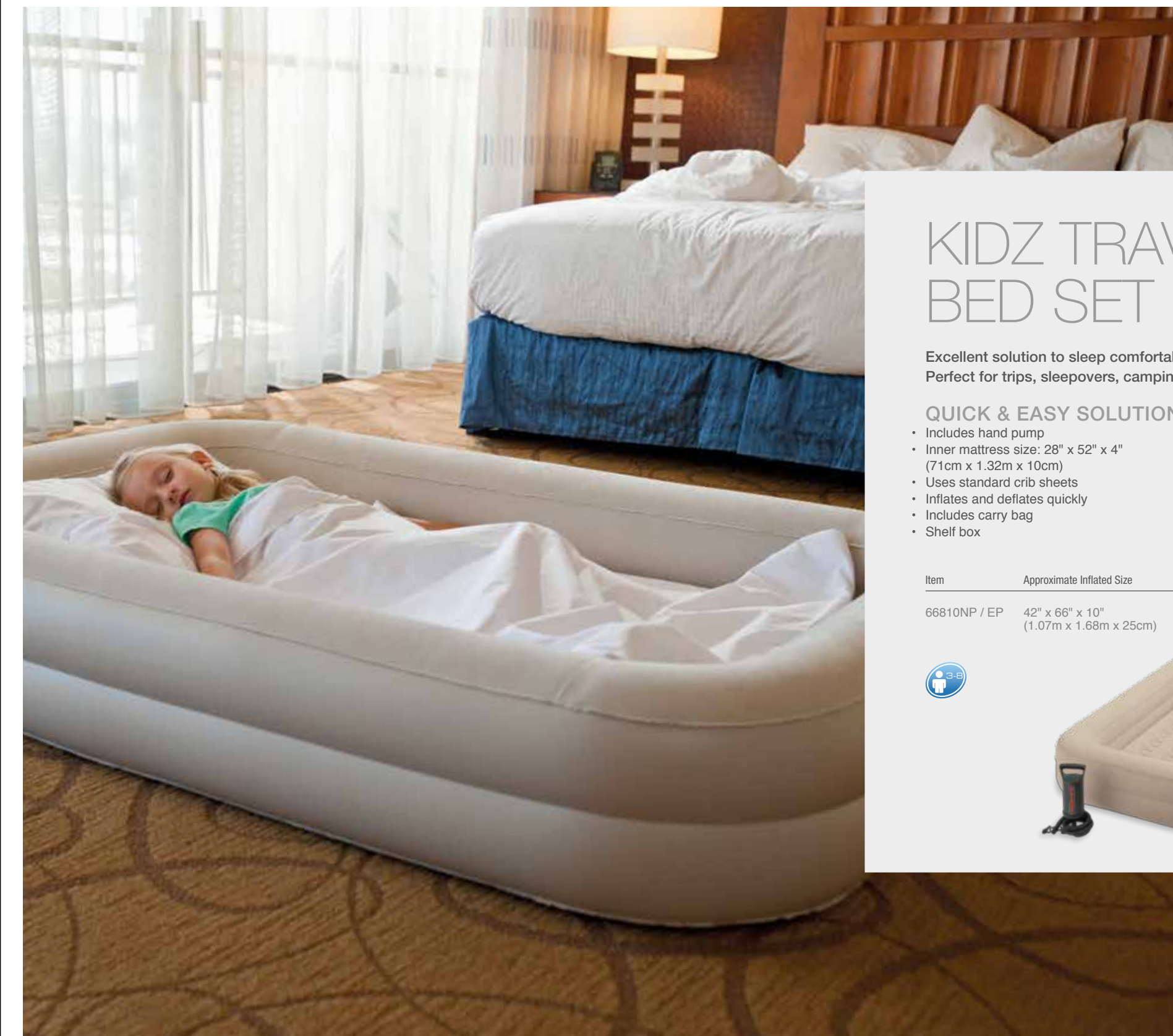
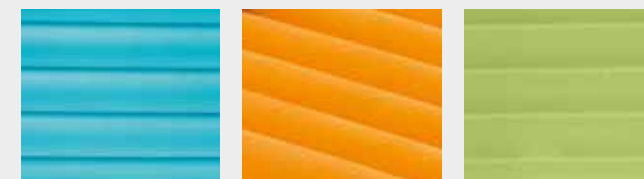

## KIDZ TRAVEL BED SET

Excellent solution to sleep comfortably when away from home. Perfect for trips, sleepovers, camping and even for nap times!

### QUICK & EASY SOLUTION

- Includes hand pump
- Inner mattress size: 28" x 52" x 4" (71cm x 1.32m x 10cm)
- Uses standard crib sheets
- Inflates and deflates quickly
- Includes carry bag
- Shelf box



Sleep area is  
28" x 52" (71cm x 1.32m)  
with soft frame surround

Item	Approximate Inflated Size	Hand Pump	Case Pack	Case Weight
66810NP / EP	42" x 66" x 10" (1.07m x 1.68m x 25cm)	68612	3 ea	29.0 lb (13.2 kg)





# ACCESSORIES

## PILLOWS

### #68678NP / EP Kidz Travel Pillows



- Frog: 11" x 12" x 3" (28cm x 30cm x 8cm)
- Cat: 12" x 11" x 3" (30cm x 28cm x 8cm)
- Child-friendly designs
- Soft flocking for extra comfort
- Pegable box
- 36 ea, asst 7.4 lb (3.4 kg)



### #68675 / E Travel Pillow

- 14" x 12" x 4" (36cm x 30cm x 10cm)
- Black super soft Velvetaire™ flocked surface
- Perfect for those long plane and car trips
- Contoured for neck support
- Folds up for easy travel
- Pegable box
- 36 ea, 8.4 lb (3.8 kg)



### #68672 / E Downy Pillow

- 17" x 11" x 3½" (43cm x 28cm x 9cm)
- I-beam construction
- Pegable box
- 24 ea, 10.4 lb (4.7 kg)



### #68676NP / EP Kidz Pillows



- 17" x 11" x 3½" (43cm x 28cm x 9cm)
- Available in Sunny Orange, Sky Blue and Lime Green
- Pegable box
- 24 ea, asst 10.4 lb (4.7 kg)



### #68670 / E 2-in-1 Pillow Cushion

- 23" x 14" x 5" (58cm x 36cm x 13cm)
- Super plush Velvetaire™ flocked surface for comfort and convenience
- Superior design for lumbar support
- Pegable box
- 12 ea, 8.1 lb (3.7 kg)

new!



## LED LIGHT



### #68691 / E Deluxe 5-in-1 LED Light

- Built-in lithium rechargeable battery
- Optics design with 10x zoom lens
- 360 degree beacon
- USB charger cable
- 12V charger adaptor
- Durable water resistant and impact resistant construction
- Shelf box
- 6 ea, 8.7 lb (3.9 kg)



12 volt charger adaptor



USB charger cable

### FUNCTION

### OPERATION

Flashlight	Choose between three power levels (8%, 50%, 100%) plus adjustable focus to meet all flashlight needs.
Hanging Lantern	Choose between three power levels to operate in floodlight mode with lantern suspended.
Table Top Lantern	Select lantern mode: 8% power level is perfect for a nightlight, while 50% and 100% levels are ideal to light up rooms, garages, RVs, or tents.
Hazard Light	Flashes an amber-colored warning light. A must-have for car & boat owners, campers, and other travelers.
Emergency Beacon	At full power, the international SOS signal autoflashes at up to a full kilometer, easily recognizable by rescue personnel.



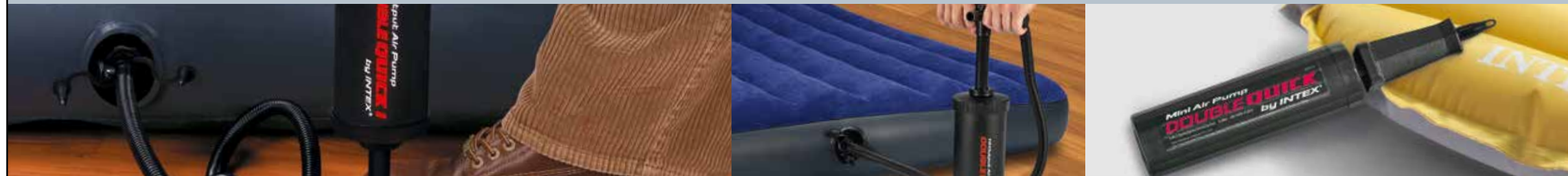

MANUAL PUMPS

**#68612 / E  
Double Quick I  
Hand Pump**

- 11½" (29cm)
- 3 interconnecting nozzles with hose
- TUV RL approved
- Inflates on both up and down strokes
- Shelf box  
12 ea, 11.1 lb (5.0 kg)



**#68614 / E  
Double Quick II  
Hand Pump**

- 2 times the air flow of #68612
- 14" (36cm)
- 3 interconnecting nozzles with hose
- TUV RL approved
- Inflates on both up and down strokes
- Shelf box  
4 ea, 6.1 lb (2.8 kg)



**#68605 / E  
Double Quick III S  
Hand Pump**

- 3 times the air flow of #68612
- 14½" (37cm)
- 3 interconnecting nozzles with hoses
- TUV RL approved
- Inflates and deflates
- Pumps on up and down strokes
- Shelf box  
3 ea, 6.5 lb (3.0 kg)



**#68615 / E  
Double Quick III  
Hand Pump**

- 3½ times the air flow of #68612
- 19" (48cm)
- TUV RL approved
- Large nozzle threaded for athletic ball inflating needle (one included)
- Inflates athletic balls up to 8 psi
- Inflates and deflates
- Pumps on up and down strokes
- Shelf box  
3 ea, 9.0 lb (4.1 kg)



U.S. Patent  
No. 6,299,420

**#69613 / E  
Double Quick Mini Hand Pump**

- 11½" (29cm)
- TUV RL approved
- Inflates on fore and back strokes
- Shelf box  
24 ea, 7.3 lb (3.3 kg)



improved!

**#69611 / E  
Bellows Foot Pump**

- 11" (28cm)
- TUV RL approved
- Inflates and deflates
- Shrink wrapped with litho label
- Shelf box  
6 ea, 8.4 lb (3.8 kg)



**#68610 / E  
Giant Bellows Foot Pump**

- 50% more air flow than of #69611
- 12" (30cm)
- TUV RL approved
- Inflates and deflates
- Shelf box  
6 ea, 13.6 lb (6.2 kg)





# ACCESSORIES

## ELECTRIC PUMPS

These Quick-Fill™ electric pumps have a sleek, aerodynamic design that fits perfectly in the palm of your hand, yet still inflate even the largest of inflatables in a breeze.

### Quick-Fill™ AC/DC Electric Pump features include:

- 3 interconnecting nozzles
- 12V DC & AC power adapter for easy Outdoor and Indoor use
- ETL approved (110-120V)
- CE approved (220-240V)
- Shelf box



#66631 (110-120V)  
#66632 (220-240V)

### Quick-Fill™ DC Electric Pump features include:

- 3 interconnecting nozzles
- Plug into 12V DC automobile cigarette lighter or 12V DC accessory outlet
- ETL approved
- CE, GS approved
- Shelf box



#66626 (12V)

### Quick-Fill™ AC Electric Pump features include:

- 3 interconnecting nozzles
- Thermo protector incorporated for safety
- ETL approved (110-120V)
- CE, GS approved (220-240V)
- Shelf box



#66619 (110-120V)  
#66620 (220-240V)

### Quick-Fill™ RECHARGEABLE Pump features include:

- 3 interconnecting nozzles
- A 12V DC power adapter for vehicle charging and a household AC power adapter for home charging
- 12V DC to inflate and deflate while recharging
- Automatic over-charge cut off for safety protection
- New shape with easy carry handle
- ETL approved (110-120V)
- CE approved (220-240V)
- Shelf box



#66621 (110-120V)  
#66622 (220-240V)

### Quick-Fill™ AC Electric Pump features include:

- 3 interconnecting nozzles with hose
- Thermo protector incorporated for safety
- New shape with easy carry handle
- ETL approved (110-120V model)
- CE, GS approved (220-240V model)
- Shelf box



#66623 (110-120V)  
#66624 (220-240V)

### Quick-Fill™ High PSI Indoor/outdoor Electric Pump features include:

- 3 interconnecting nozzles with hose
- For both indoor and outdoor use - plugs into cigarette lighter or household electrical outlet
- 2-speed switch
- Inflates athletic balls up to 12 psi
- Detachable DC cigarette cord
- ETL approved (110-120V)
- CE, GS approved (220-240V)
- Shelf box



#68608 (110-120V)  
#68609 (220-240V)



#68638

### Quick-Fill™ BATTERY Pump features include:

- 24% more air flow than previous version (#68639)
- Operates on 6 C-cell size batteries
- 3 interconnecting nozzles
- CE approved
- Shelf box

- Outdoor & Indoor Use
- AC or Car
- Nozzles Fit Any Valve Size

- Outdoor & Indoor Use
- 6 C Batteries Required (not included)
- Nozzles Fit Any Valve Size

Item #	Voltage			Disposable Batteries	Outdoor Use	Accordion Hose with 3 Nozzles	3 Interconnecting Nozzles	Max. Air Flow (L/min)	Case Pack	Weight lb (kg)
	110-120 AC	220-240 AC	12 DC							
66631E	•		•		•		•	≥450 (15.9CFM)	6	13.0 (5.9)
66632		•	•		•		•	≥450 (15.9CFM)	6	13.1 (6.0)
68638 / E				6 x C	•		•	≥380 (13.4CFM)	6	6.4 (2.9)
66626 / E			•		•		•	≥600 (21.2CFM)	6	8.7 (4.0)
66619E	•						•	≥600 (21.2CFM)	6	8.8 (4.0)
66620		•					•	≥600 (21.2CFM)	6	8.6 (3.9)
66623E	•					•	•	≥1100 (38.9CFM)	4	11.1 (5.1)
66624		•				•	•	≥1100 (38.9CFM)	4	11.1 (5.1)
68608E	•		•		•		•	≥400 (14.1CFM)	4	30.3 (13.8)
68609		•	•		•		•	≥400 (14.1CFM)	4	30.3 (13.8)
66621E	•		•		•		•	≥600 (21.2CFM)	4	11.1 (5.0)
66622		•	•		•		•	≥600 (21.2CFM)	4	11.1 (5.0)



**64411**  
DURA-BEAM®



P. 16-17

			Approximate Inflated Size	Built-in Pump
64411E	Twin	39" x 75" x 18"	(99cm x 1.91m x 46cm)	110 - 120V 220 - 240V
64412				
64413E	Queen	60" x 80" x 18"	(1.52m x 2.03m x 46cm)	110 - 120V 220 - 240V
64414				

**64417**  
DURA-BEAM®

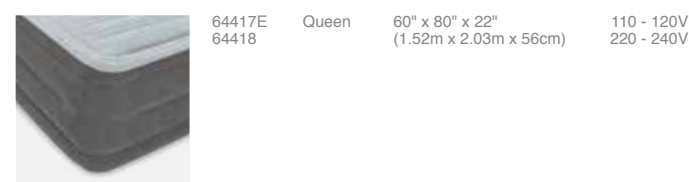

P. 16-17

			Approximate Inflated Size	Built-in Pump
64417E	Queen	60" x 80" x 22"	(1.52m x 2.03m x 56cm)	110 - 120V 220 - 240V
64418				

**64421** *new!*  
DURA-BEAM®

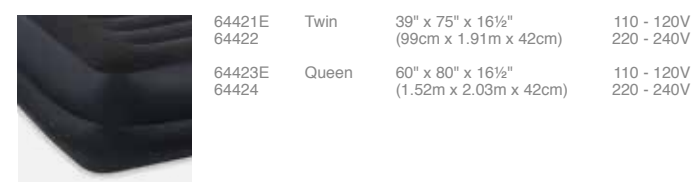

P. 14-15

			Approximate Inflated Size	Built-in Pump
64421E	Twin	39" x 75" x 16½"	(99cm x 1.91m x 42cm)	110 - 120V 220 - 240V
64422				
64423E	Queen	60" x 80" x 16½"	(1.52m x 2.03m x 42cm)	110 - 120V 220 - 240V
64424				

**64431** *new!*  
DURA-BEAM®

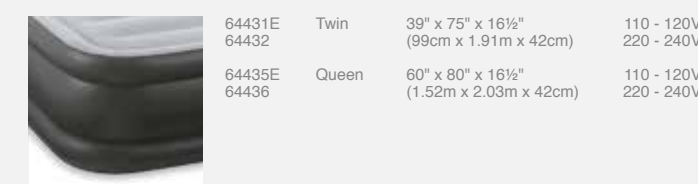

P. 18-19

			Approximate Inflated Size	Built-in Pump
64431E	Twin	39" x 75" x 16½"	(99cm x 1.91m x 42cm)	110 - 120V 220 - 240V
64432				
64435E	Queen	60" x 80" x 16½"	(1.52m x 2.03m x 42cm)	110 - 120V 220 - 240V
64436				

**64439** *new!*  
DURA-BEAM®

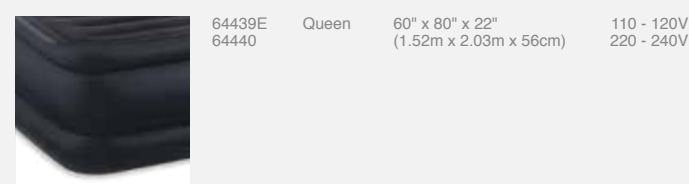

P. 20-21

			Approximate Inflated Size	Built-in Pump
64439E	Queen	60" x 80" x 22"	(1.52m x 2.03m x 56cm)	110 - 120V 220 - 240V
64440				

**64455** *new!*  
DURA-BEAM®



P. 22-23

			Approximate Inflated Size	Built-in Pump
64455E	Twin	39" x 75" x 18"	(99cm x 1.91m x 46cm)	110 - 120V 220 - 240V
64456				
64457E	Queen	60" x 80" x 18"	(1.52m x 2.03m x 46cm)	110 - 120V 220 - 240V
64458				

**64459** *new!*  
DURA-BEAM®

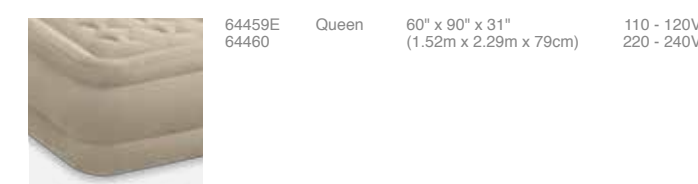

P. 28-29

			Approximate Inflated Size	Built-in Pump
64459E	Queen	60" x 90" x 31"	(1.52m x 2.29m x 79cm)	110 - 120V 220 - 240V
64460				

**64461** *new!*  
DURA-BEAM®



P. 24-25

			Approximate Inflated Size	Built-in Pump
64461E	Twin	39" x 75" x 20"	(99cm x 1.91m x 51cm)	110 - 120V 220 - 240V
64462				
64463E	Queen	60" x 80" x 20"	(1.52m x 2.03m x 51cm)	110 - 120V 220 - 240V
64464				

**64467** *new!*  
DURA-BEAM®

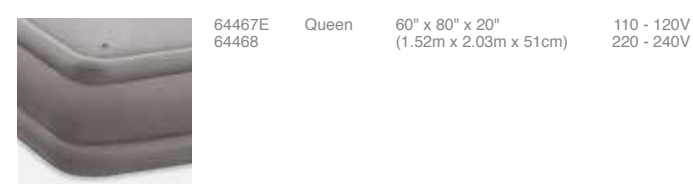

P. 26-27

			Approximate Inflated Size	Built-in Pump
64467E	Queen	60" x 80" x 20"	(1.52m x 2.03m x 51cm)	110 - 120V 220 - 240V
64468				

**64471**  
PREMAIRE®



P. 32-33

			Approximate Inflated Size	Built-in Pump
64471E	Twin	39" x 75" x 18"	(99cm x 1.91m x 46cm)	110 - 120V 220 - 240V
64472				
64473E	Queen	60" x 80" x 18"	(1.52m x 2.03m x 46cm)	110 - 120V 220 - 240V
64474				

**64701**  
DURA-BEAM®



P. 12-13

			Approximate Inflated Size	
64701 / E	Twin	39" x 75" x 10"	(99cm x 1.91m x 25cm)	
64702 / E	Full	54" x 75" x 10"	(1.37m x 1.91m x 25cm)	
64703 / E	Queen	60" x 80" x 10"	(1.52m x 2.03m x 25cm)	

**64780**



P. 37

			Approximate Inflated Size	Hand Pump
64780 / E	Cot Size	30" x 75" x 5"	(76cm x 1.91m x 13cm)	68612



**64791**

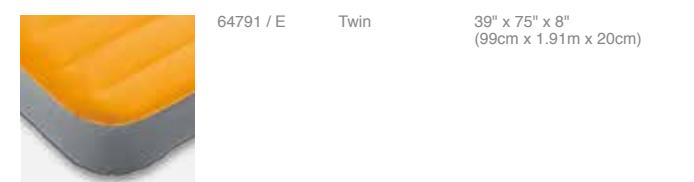

P. 36

			Approximate Inflated Size	
64791 / E	Twin	39" x 75" x 8"	(99cm x 1.91m x 20cm)	

**66767**

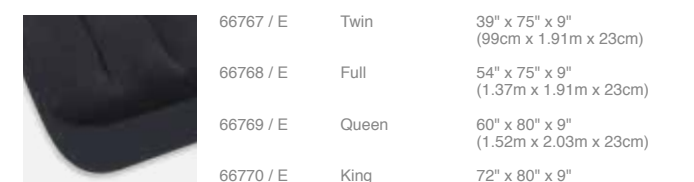

P. 44-45

			Approximate Inflated Size	
66767 / E	Twin	39" x 75" x 9"	(99cm x 1.91m x 23cm)	
66768 / E	Full	54" x 75" x 9"	(1.37m x 1.91m x 23cm)	
66769 / E	Queen	60" x 80" x 9"	(1.52m x 2.03m x 23cm)	
66770 / E	King	72" x 80" x 9"	(1.83m x 2.03m x 23cm)	

			Approximate Inflated Size	Built-in Pump
66775E	Twin	39" x 75" x 9"	(99cm x 1.91m x 23cm)	110 - 120V 220 - 240V
66779				
66776E	Full	54" x 75" x 9"	(1.37m x 1.91m x 23cm)	110 - 120V 220 - 240V
66780				
66777E	Queen	60" x 80" x 9"	(1.52m x 2.03m x 23cm)	110 - 120V 220 - 240V
66781				

**66801**

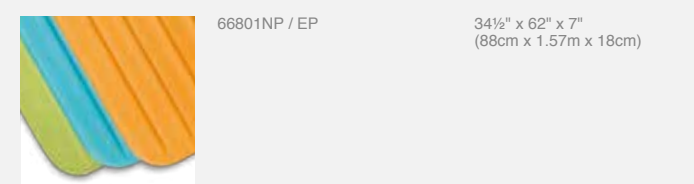

P. 62

			Approximate Inflated Size	
66801NP / EP			34½" x 62" x 7"	(88cm x 1.57m x 18cm)

**66810**

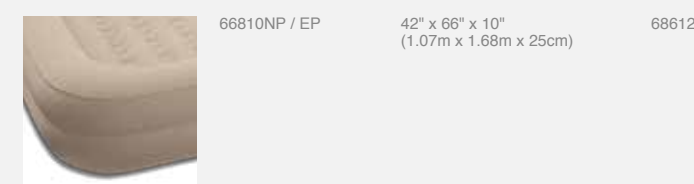

P. 63

			Approximate Inflated Size	Hand Pump
66810NP / EP			42" x 66" x 10"	(1.07m x 1.68m x 25cm)
				68612

**66950**



P. 39

			Approximate Inflated Size	
66950 / E	Cot Size	30" x 75" x 8¾"	(76cm x 1.91m x 22cm)	
66927 / E	Twin	39" x 75" x 8¾"	(99cm x 1.91m x 22cm)	
66928 / E	Full	54" x 75" x 8¾"	(1.37m x 1.91m x 22cm)	
66929 / E	Queen	60" x 80" x 8¾"	(1.52m x 2.03m x 22cm)	

**64459** *new!*  
DURA-BEAM®

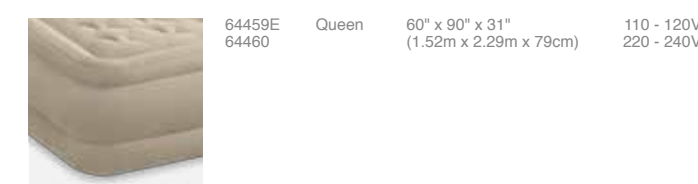

P. 28-29

			Approximate Inflated Size	Built-in Pump
64459E	Queen	60" x 90" x 31"	(1.52m x 2.29m x 79cm)	110 - 120V 220 - 240V
64460				

**64461** *new!*  
DURA-BEAM®



P. 24-25

			Approximate Inflated Size	Built-in Pump
64461E	Twin	39" x 75" x 20"	(99cm x 1.91m x 51cm)	110 - 120V 220 - 240V
64462				
64463E	Queen	60" x 80" x 20"	(1.52m x 2.03m x 51cm)	110 - 120V 220 - 240V
64464				

**64467** *new!*  
DURA-BEAM®

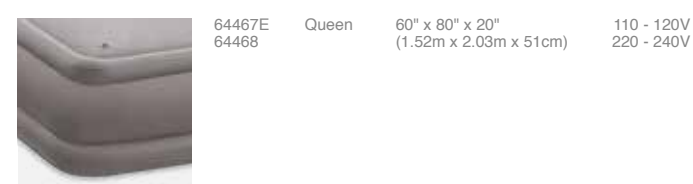

P. 26-27

			Approximate Inflated Size	Built-in Pump
64467E	Queen	60" x 80" x 20"	(1.52m x 2.03m x 51cm)	110 - 120V 220 - 240V
64468				

**66967**

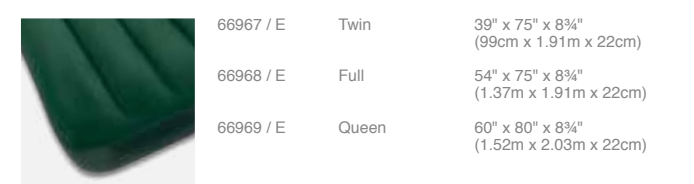

P. 40-41

			Approximate Inflated Size	
66967 / E	Twin	39" x 75" x 8¾"	(99cm x 1.91m x 22cm)	
66968 / E	Full	54" x 75" x 8¾"	(1.37m x 1.91m x 22cm)	
66969 / E	Queen	60" x 80" x 8¾"	(1.52m x 2.03m x 22cm)	

**67765**  
DURA-BEAM®



P. 16-17

			Approximate Inflated Size	Built-in Pump
67765E	Twin	39" x 75" x 13"	(99cm x 1.91m x 33cm)	110 - 120V 220 - 240V
67766				
67767E	Full	54" x 75" x 13"	(1.37m x 1.91m x 33cm)	110 - 120V 220 - 240V
67768				
67769E	Queen	60" x 80" x 13"	(1.52m x 2.03m x 33cm)	110 - 120V 220 - 240V
67770				

**68708** *new!*



P. 35

			Approximate Inflated Size	
68708 / E	Cot Size	30" x 72" x 4"	(76cm x 1.83m x 10cm)	

**68797**

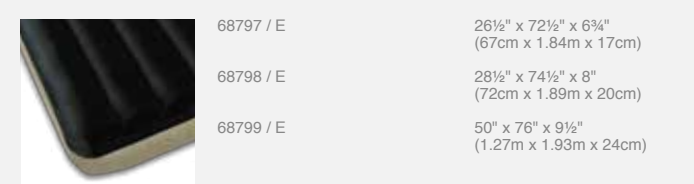

P. 38

			Approximate Inflated Size	
68797 / E			26½" x 72½" x 6¾"	(67cm x 1.84m x 17cm)
68798 / E			28½" x 74½" x 8"	(72cm x 1.89m x 20cm)
68799 / E			50" x 76" x 9½"	(1.27m x 1.93m x 24cm)

**68950**

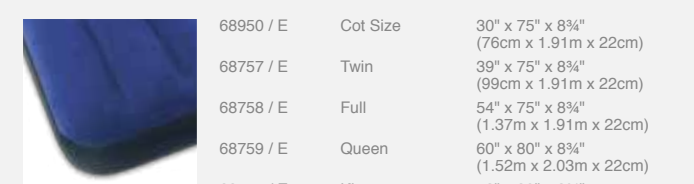

P. 42-43

			Approximate Inflated Size	
68950 / E	Cot Size	30" x 75" x 8¾"	(76cm x 1.91m x 22cm)	
68757 / E	Twin	39" x 75" x 8¾"	(99cm x 1.91m x 22cm)	
68758 / E	Full	54" x 75" x 8¾"	(1.37m x 1.91m x 22cm)	
68759 / E	Queen	60" x 80" x 8¾"	(1.52m x 2.03m x 22cm)	
68755 / E	King	72" x 80" x 8¾"	(1.83m x 2.03m x 22cm)	

			Approximate Inflated Size	Hand Pump
68765 / E	Queen	60" x 80" x 8¾"	(1.52m x 2.03m x 22cm)	68612